

this
is **U**
ThINKing!
INSIDE!

ULTIMATE SERIES

Welcome to NOGA MT **Pioneering Precision Since 1980**

For over four decades, NOGA has been at the forefront of precision engineering, delivering innovative deburring solutions that set the benchmark for industry excellence.

Our esteemed ULTIMATE SERIES features specialized tools such as UBURR for front and back deburring, UBACK with USPOT for through-hole counterboring and UCHAMF for through-hole countersinking, and UFIBER, a line of advanced ceramic fiber brushes crafted to deliver exceptional precision and durability in surface treatment applications.

From our beginnings with hand deburring tools to the development of advanced machine deburring systems under NOGA MT (NOGA Machine Tools), we proudly serve the rigorous demands of metalworking and machining professionals across the globe.



Always evolving

ULTIMATE THE PRODUCT! LINES

OUR ULTIMATE PRODUCT LINES

UFIBER

Discover the future of surface finishing with UFIBER, our advanced nano-technology ceramic fiber brushes. UFIBER delivers exceptional performance in deburring, polishing, and surface finishing, making it the perfect choice for a wide range of materials, including hardened steels, superalloys like Titanium, Inconel and composite materials. Versatile in application, UFIBER is designed for both automated systems and manual operation, offering unmatched efficiency and precision across industries worldwide.

UBACK

The UBACK, brings together the innovative UX Tool-holders powered by MT DURASHIELD with the advanced SolidCAM software and USPOT/UCHAMF inserts to redefine machining precision. Featuring a patented hydraulic mechanism that ingeniously uses the machine's coolant liquid, this system delivers exceptional control over insert movement.

THE RESULT - Unparalleled accuracy, repeatability and streamlined operations for back counterboring, back countersinking, and back spot-facing tasks.

With its advanced engineering, ULTIMATE Back eliminates the need for workpiece rotation, effortlessly performing operations in a single pass while significantly boosting productivity and efficiency.

UBURR

Revolutionary automatic deburring tools featuring precision-engineered cutting blades with innovative geometry, complemented by our **MT DURASHIELD** advanced tool-holders. UBURR represents the perfect fusion of efficiency and precision in automated deburring processes.

ULTIMATE THE PRODUCT ! LINES

THE NOGA MT DIFFERENCE

Our commitment to excellence extends beyond our products. With a dedicated team of industry professionals, we provide:

EXPERT TECHNICAL SUPPORT AND CONSULTATION

INNOVATIVE SOLUTIONS FOR COMPLEX MACHINING CHALLENGES

RESPONSIVE CUSTOMER SERVICE

Ready to elevate your manufacturing process?

Discover how NOGA MT's precision engineering solutions can enhance your machining operations. Our comprehensive range of products combines innovation with reliability to deliver superior results for your specific applications.

Excellence in engineering, precision in practice - NOGA MT

ULTIMATE THE SERIES !

UBACK

Tool Holders Support Pilot Hole Diameters Ød
Ranging from Ø8.0-25.0mm (0.315-0.984")

UFIBER



Ceramic Fiber Brushes

For Inner-holes, Cross-holes
Ød Range of:
Ø1-20mm (0.0394-0.787")
For Surfaces Ød Range of
Ø6-100mm (0.236-3.937")
Available in 10 Grit Levels
from #150 to #6000

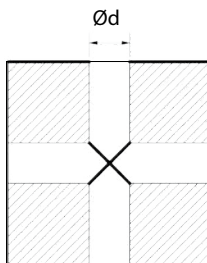

USPOT



Through-hole Back Counterbore or Spotfacing

Diameters from
Ø8.5-57.5mm (0.335-2.264")
Semi-Standard or
Tailor-made Inserts

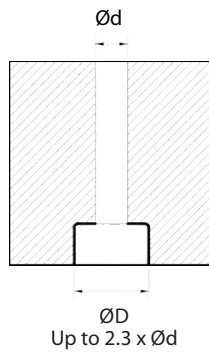

UCHAMF



Through-hole Back Countersink or Chamfering

Diameters from
Ø8.5-46.0mm (0.335-1.811")
Available with Standard 82°
and 90° Countersink Inserts

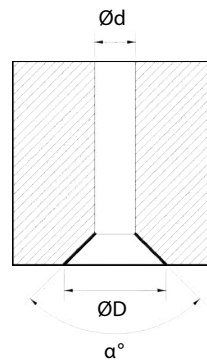

UBURR



Front and Back Deburring

Ød Range of Ø2.5-25mm
(0.098-0.984")

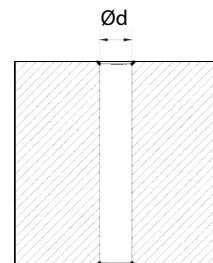

ULTIMATE TABLE OF CONTENTS



UFIBER

Advanced ceramic brushes for precision and durability in surface treatment.

The new UFiber line of advanced ceramic fiber brushes is designed to meet the highest standards of precision and durability in surface treatment applications, achieving superior surface finishes while maximizing efficiency.

Grit Sizes: #150 to 6000

PAGES 8-20



UBACK TOOL-HOLDERS

The perfect combination of UBACK Tool-holders and UCHAMF & USPOT inserts.

A sophisticated mechanism that allows a high level of accuracy to be achieved. The opening and closing of the blade is done by opening and closing the coolant liquid from the machine.

Pilot-hole range from Ø8mm (0.315") up to Ø25mm (0.984")

PAGES 21-39



UBURR

Deburring the front and back of a drilled through hole.

UBurr deburring tools providing a quick, effective, reliable and consistent deburring way of front and back side bore edges of a drilled hole in one single pass.

Efficient and convenient tools for long-term work and competitive prices

Pilot-hole range from Ø2.5mm (0.0984") up to Ø25mm (0.984")

PAGES 40-55



USPOT INSERTS

Back Counterbore or back Spotfacing of a drilled through hole.

Diameter range from Ø8.5-57.5mm (Ø335-2.264").

Available as Semi-Standard Inserts.

PAGES 26-29



UCHAMF INSERTS

Back Chamfering or back Countersink of a drilled through hole.

Diameters from Ø8.5-46.0mm (Ø335-1.811").

Available with Standard 82° and 90° Countersink Inserts and Semi-Standard Inserts.

PAGES 30-33

ULTIMATE DURASHIELD!

A MARK OF EXCELLENCE



DURASHIELD represents NOGA MT's commitment to premium quality tool-holders. When you spot this distinctive logo, you're assured of a product engineered for superior performance in the most challenging industrial applications, manufactured from Precipitation Hardened AISI 17-4 PH for outstanding durability and performance.

These tool-holders establish new industry benchmarks through:

ADVANCED corrosion resistance technology.

ENHANCED structural integrity.

EXTENDED tool life capabilities.

EXCEPTIONAL performance standards.

UNMATCHED reliability in demanding environments.

ULTIMATE DURASHIELD!

MT DURASHIELD CORE FEATURES

PERFORMANCE CHARACTERISTICS

SUPERIOR STRENGTH: Engineered to handle heavy-duty loads with confidence.

ENHANCED TOUGHNESS: Maintains consistent reliability under the most demanding operational conditions.

ADVANCED WEAR RESISTANCE: Significantly extends tool lifespan while reducing operational costs.

PRECISION MACHINABILITY: Enables the creation of highly precise tool-holder designs.

THERMAL RESILIENCE: Maintains optimal performance even at elevated temperatures.

CORROSION PROTECTION: Specifically designed to withstand harsh industrial environments.

ENVIRONMENTAL INNOVATION

The NOGA MT **DURASHIELD** tool-holder line features an innovative passivation process that:

ENHANCES corrosion resistance naturally.

ELIMINATES the need for additional protective coatings.

REMOVES requirements for supplementary chemicals.

STREAMLINES the production process.

REDUCES environmental impact.

PROVIDES an environmentally conscious approach to corrosion protection.

U ULTIMATE U FIBER! BRUSHES

ADVANCED CERAMIC BRUSHES



NOGA MT is excited to introduce the new **UFIBER** Brush, a line of advanced ceramic fiber brushes designed to meet the highest standards of precision and durability in surface treatment applications.

ULTIMATE UFIBER! BRUSHES

ADVANCED CERAMIC BRUSHES

FOR PRECISION AND DURABILITY IN SURFACE TREATMENT

NOGA MT's **UFIBER** brushes are revolutionizing surface treatment with nano-technology precision. These advanced ceramic brushes deliver unparalleled performance, durability, and efficiency for various industrial applications, offering a comprehensive solution for deburring, polishing and finishing tasks.

MAIN BENEFITS

NANO-TECHNOLOGY PRECISION

- Superior surface roughness control.
- Enhanced wear resistance for extended tool life.
- Reduced production costs through fewer tool changes.

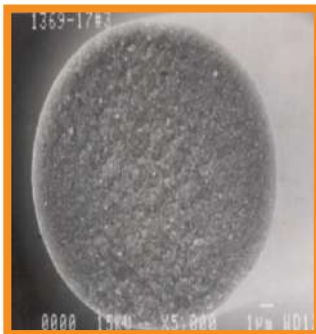

NOGA NANO TECHNOLOGY

**UNMATCHED
PRECISION**

**CUTTING-EDGE
TECHNOLOGY**

**SUPERIOR
PERFORMANCE**

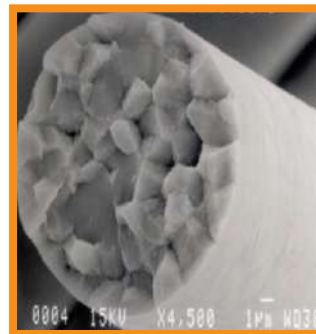

COMPETITORS

**LIMITED
PRECISION**

**OUTDATED
TECHNOLOGY**

**LOWER
DURABILITY**

3-IN-1 FUNCTIONALITY

- Combines deburring, polishing, and finishing in one tool.
- Streamlines operations by reducing tool inventory needs.

AUTOMATION READY

- Seamless integration with CNC machines and robotic arms.
- Enables advanced manufacturing with minimal manual intervention.

WIDE GRIT RANGE

- **UFIBER** bristles are available in 10 different grits ranging from #150 to #6000, providing flexibility to handle various work materials and burr conditions.

UFIBER

GRIT OPTIONS



Wide Grit Range **UFIBER** bristles are available in grits ranging from #150 to #6000, providing flexibility to handle various work materials and burr conditions.

ENHANCED SURFACE FINISHING:

Achieves significantly smoother finishes even on tough materials like hardened steels and composites.

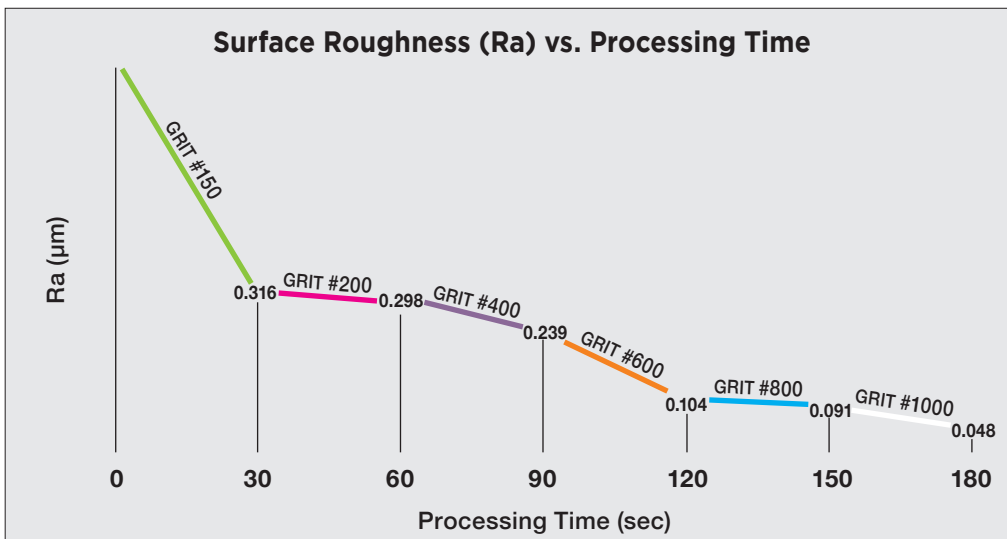

- Material: SAE 1050 / S50C / Wr. 1.1206
- Rotational speed: 3200 rpm

TIME EFFICIENCY:

UFIBER brushes achieve a 20 X faster machining time compared to manual work (defined as any operation performed by hand without automation) delivering unparalleled efficiency and productivity in automated deburring and polishing.

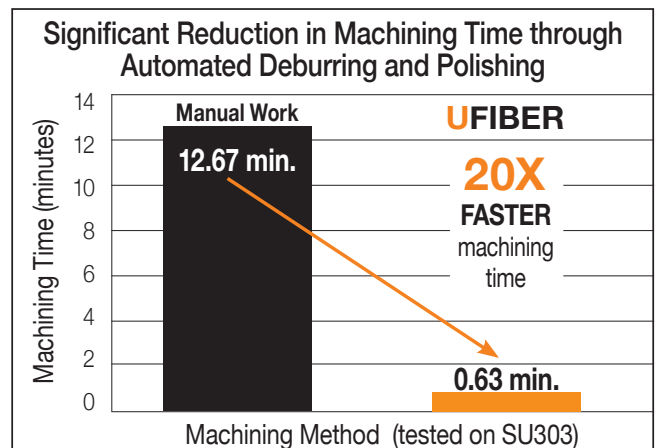

UFIBER

ADDITIONAL FEATURES

VERSATILE APPLICATIONS:

- Compatible with machining centers, lathe machines, drilling machines, robots and hand micromotor devices.

SELF-SHARPENING EDGES:

- Enables consistent grinding performance throughout the tool's life span.

POWERFUL AND DURABLE:

- Strong grinding properties with cutting edges that remain intact for a longer life span.

EXCELLENT SURFACE FINISHES:

- Achieves precise deburring and smooth finishes effortlessly.

COMBINED OPERATIONS:

- Performs deburring and surface finishing in a single operation.

LONG SERVICE LIFE:

- Maximizes productivity and minimizes costs with extended durability.

EASY MAINTENANCE:

- The brushes can be ground or cut to renew their cutting edge.

COMPARATIVE ANALYSIS

FEATURE	UFIBER by NOGAMT	COMPETITOR X
MATERIAL TECHNOLOGY	Latest Nano-technology ceramic fibers	Micro-technology ceramic fibers
GRIT RANGE	10 different grit sizes ranges from #150 to #6000	Limited to standard industrial grits
PERFORMANCE	20% faster processing time	Consistent edge retention
DURABILITY	High resistance to wear and deformation	Moderate durability
MATERIAL SUITABILITY	All materials including composites	Metals and selected alloys
TOOL LIFE	High tool-life Due to higher Material Suitability	Lower tool-life Due to lower Material Suitability

UFIBER

APPLICATIONS & PRODUCT RANGE

CROSS-HOLE BRUSH



SURFACE BRUSH

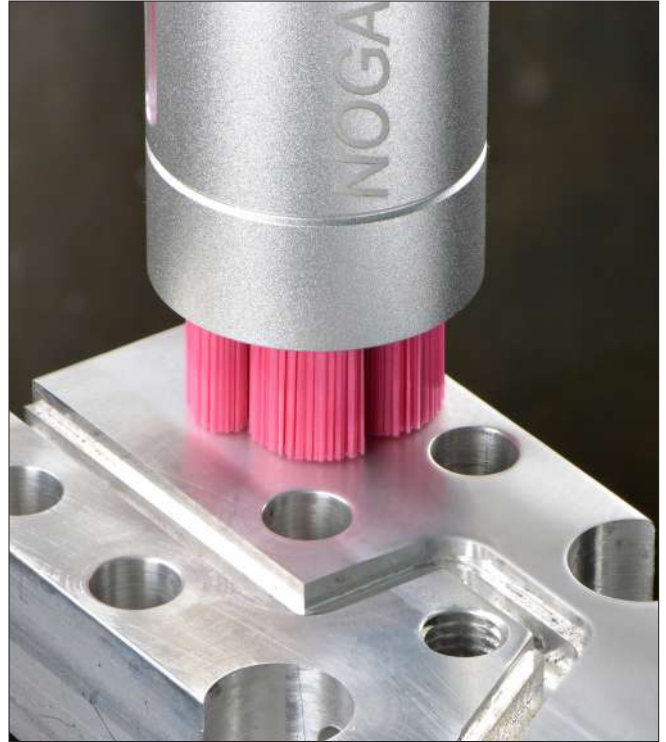

POINT BRUSH



END BRUSH

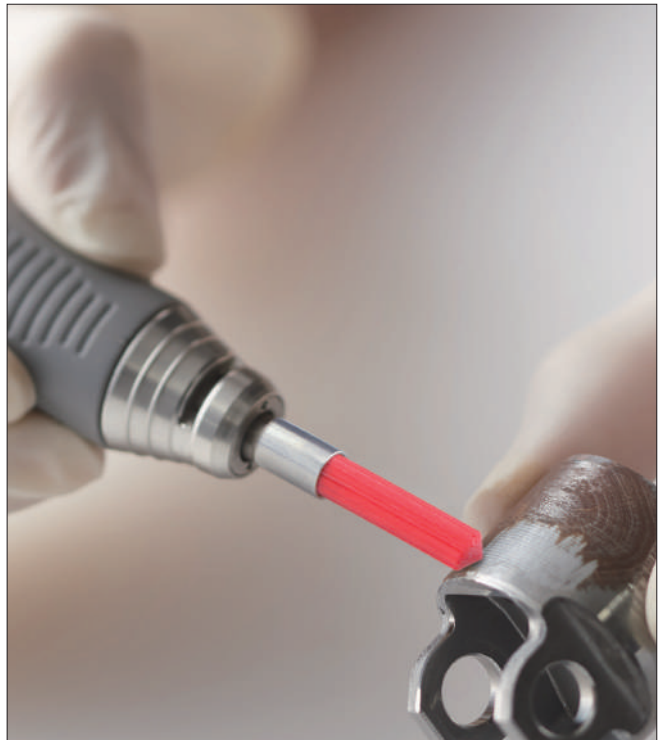

UFIBER

INDUSTRY APPLICATIONS



AEROSPACE

Ensures compliance with strict safety and performance standards for aircraft components.

AUTOMOTIVE

Deburrs and polishes engine and transmission parts with precision.



MEDICAL DEVICES

Provides smooth finishes for surgical instruments and implants.

GENERAL MANUFACTURING

Versatile for metalworking, plastics and composites.



UFIBER

CROSS-HOLE BRUSHES

Designed for inner diameter polishing and cross-hole burr removal. The brush expands due to centrifugal forces, allowing it to conform precisely to the pilot hole diameter, making it versatile for various applications.



- Available Range: **Ø1.5, 3.0, 5.0, 7.0 mm / 0.059, 0.118, 0.197, 0.276"** and 10 grit sizes for each diameter.
- Expansion Range: **Ø3.5-20mm / 0.138-0.787"**

SURFACE BRUSHES

Designed for surface polishing and deburring, ideal for achieving uniform finishes on flat surfaces. Tip-cutting brushes are designed to fit into a sleeve with the tool shank, making them ideal for automated deburring in CNC machines, robots and other equipment.



The surface brush can also function as a cross-hole brush, leveraging centrifugal force during rotation to expand and efficiently remove fine burrs from the inner surfaces of cylinders.



UF1625 / UF-FB-W-D025-L75 at 5000 rpm UF1725 / UF-FB-R-D025-L75 at 5000 rpm

- Available Range: **Ø6, 15, 25, 40, 60, 100 mm / 0.236, 0.590, 0.984, 1.575, 2.362, 3.937"** and 10 grit sizes for each diameter.

UFIBER

POINT BRUSHES

Suitable for precision work in small or complex geometrical areas. Ideal for removing cutter marks, polishing, and finishing parts with small or narrow geometrical features. Suitable for use in CNC machines, robots or hand-held rotary tools.

- Available Range: **Ø1.0, 1.5, 2.0, 2.5, 3.0 mm / 0.039, 0.059, 0.079, 0.098, 0.118"** and 10 grit sizes for each diameter.



END BRUSHES

Designed for use with hand-held rotary tools and CNC machines, making it ideal for precise finishing tasks, especially in tight or recessed areas where traditional brushes may fall short. This brush features high bending strength and can operate at max. 12000 RPM without the risk of filament breakage.

- Available Range: **Ø5mm / 0.197" - flat surface or 90° angled** and 10 grit sizes for each diameter



FLAT DESIGN

FLAT DESIGN: Designed for uniform deburring and finishing of flat surfaces and large areas.

WIDE CONTACT AREA: The flat edge ensures consistent and even surface treatment.

VERSATILE USAGE: Suitable for smoothing outer edges, planar surfaces and broader geometries.

ANGLED DESIGN

ANGLED DESIGN: Allows for easy access to tight spaces and hard-to-reach areas.

ENHANCED CONTROL: The pointed edge provides better control for selective deburring tasks.

VERSATILITY: Suitable for deburring geometries with complex shapes and sharp angles.

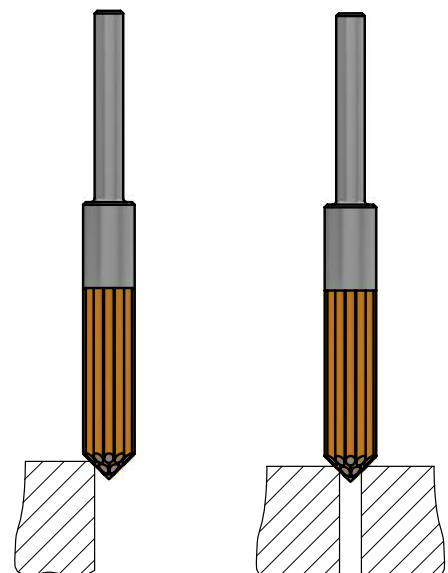

UFIBER

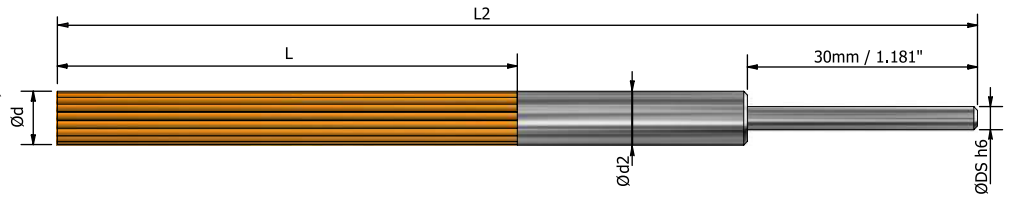

CROSS-HOLE BRUSH

SKU	DESCRIPTION	GRIT SIZE	Ø d mm / inch	L mm / inch	Ø d2 mm / inch	L2 mm / inch	Ø DS mm / inch	Wt. gram	MAX. RPM	SUITABLE PILOT-HOLE DIA.		
										GRIT #150-#1000 mm / Inch	GRIT #1200-#6000 mm / Inch	
UF2115	UF-CH-G-D015-L50	150	Ø1.5 / 0.059	50 / 1.969	Ø2.5 / 0.098	120 / 4.724	Ø3 / 0.118	3	20000	3.5 - 5 / 0.138 - 0.197	3.5 - 5 / 0.138 - 0.197	
UF2215	UF-CH-P-D015-L50	200										
UF2315	UF-CH-V-D015-L50	400										
UF2415	UF-CH-O-D015-L50	600										
UF2515	UF-CH-B-D015-L50	800										
UF2615	UF-CH-W-D015-L50	1000										
UF2715	UF-CH-R-D015-L50	1200										
UF2815	UF-CH-M-D015-L50	2000										
UF2915	UF-CH-Z-D015-L50	3000										
UF2015	UF-CH-A-D015-L50	6000										
UF2130	UF-CH-G-D030-L60	150	Ø3 / 0.118	60 / 2.362	Ø4 / 0.158	130 / 5.118	Ø3 / 0.118	6	14000	5 - 7 / 0.197 - 0.276		
UF2230	UF-CH-P-D030-L60	200										
UF2330	UF-CH-V-D030-L60	400										
UF2430	UF-CH-O-D030-L60	600										
UF2530	UF-CH-B-D030-L60	800										
UF2630	UF-CH-W-D030-L60	1000										
UF2730	UF-CH-R-D030-L50	1200		50 / 1.969						120 / 4.724	5 - 7 / 0.197 - 0.276	
UF2830	UF-CH-M-D030-L50	2000										
UF2930	UF-CH-Z-D030-L50	3000										
UF2030	UF-CH-A-D030-L50	6000										
UF2150	UF-CH-G-D050-L60	150	Ø5 / 0.197		60 / 2.362	Ø6 / 0.276	130 / 5.118	Ø6 / 0.236	17			
UF2250	UF-CH-P-D050-L60	200										
UF2350	UF-CH-V-D050-L60	400										
UF2450	UF-CH-O-D050-L60	600										
UF2550	UF-CH-B-D050-L60	800										
UF2650	UF-CH-W-D050-L60	1000										
UF2750	UF-CH-R-D050-L50	1200		50 / 1.969	120 / 4.724					8 - 10 / 0.315 - 0.394		
UF2850	UF-CH-M-D050-L50	2000										
UF2950	UF-CH-Z-D050-L50	3000										
UF2050	UF-CH-A-D050-L50	6000										
UF2170	UF-CH-G-D070-L60	150	Ø7 / 0.276			60 / 2.362	Ø8 / 0.315	130 / 5.118	Ø6 / 0.236			24
UF2270	UF-CH-P-D070-L60	200										
UF2370	UF-CH-V-D070-L60	400										
UF2470	UF-CH-O-D070-L60	600										
UF2570	UF-CH-B-D070-L60	800										
UF2670	UF-CH-W-D070-L60	1000										
UF2770	UF-CH-R-D070-L50	1200		50 / 1.969	120 / 4.724	10 - 20 / 0.394 - 0.787						
UF2870	UF-CH-M-D070-L50	2000										
UF2970	UF-CH-Z-D070-L50	3000										
UF2070	UF-CH-A-D070-L50	6000										

UFIBER

SURFACE BRUSH

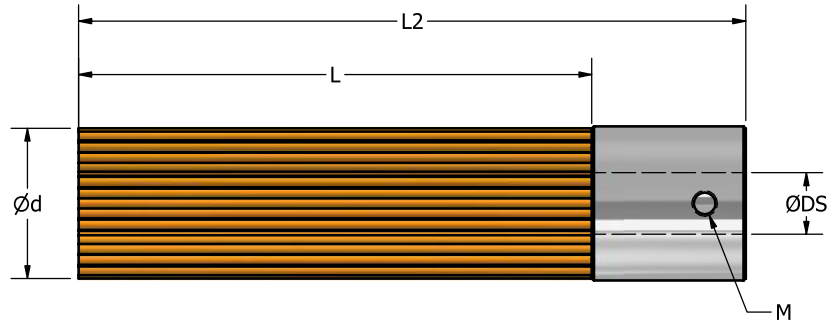

SKU	DESCRIPTION	GRIT SIZE	Ø d mm / inch	L mm / inch	L2 mm / inch	Ø DS mm / inch	SPARE ¹ PARTS (for M)			Wt. gram	
							CLAMPING SCREW M x P x L (mm)	SKU	LN KEY L (mm)		SKU
UF1106	UF-FB-G-D006-L30	150	Ø6 / 0.236	30 / 1.181	42.5 / 1.673	N/A	N/A	N/A	N/A	N/A	3
UF1206	UF-FB-P-D006-L30	200									
UF1306	UF-FB-V-D006-L30	400									
UF1406	UF-FB-O-D006-L30	600									
UF1506	UF-FB-B-D006-L30	800									
UF1606	UF-FB-W-D006-L30	1000									
UF1706	UF-FB-R-D006-L30	1200									
UF1806	UF-FB-M-D006-L30	2000									
UF1906	UF-FB-Z-D006-L30	3000									
UF1006	UF-FB-A-D006-L30	6000									
UF1115	UF-FB-G-D015-L50	150	Ø15 / 0.590	50 / 1.969	65 / 2.560	Ø6 / 0.236	M3 x 0.5 x 4	UF0019	1.5	DH0005	7
UF1215	UF-FB-P-D015-L50	200									
UF1315	UF-FB-V-D015-L50	400									
UF1415	UF-FB-O-D015-L50	600									
UF1515	UF-FB-B-D015-L50	800									
UF1615	UF-FB-W-D015-L50	1000									
UF1715	UF-FB-R-D015-L50	1200									
UF1815	UF-FB-M-D015-L50	2000									
UF1915	UF-FB-Z-D015-L50	3000									
UF1015	UF-FB-A-D015-L50	6000									
UF1125	UF-FB-G-D025-L75	150	Ø25 / 0.984	75 / 2.952	100 / 3.937	Ø9 / 0.354	M4 x 0.7 x 8	UF0018	2	DH0020	21
UF1225	UF-FB-P-D025-L75	200									
UF1325	UF-FB-V-D025-L75	400									
UF1425	UF-FB-O-D025-L75	600									
UF1525	UF-FB-B-D025-L75	800									
UF1625	UF-FB-W-D025-L75	1000									
UF1725	UF-FB-R-D025-L75	1200									
UF1825	UF-FB-M-D025-L75	2000									
UF1925	UF-FB-Z-D025-L75	3000									
UF1025	UF-FB-A-D025-L75	6000									
UF1140	UF-FB-G-D040-L75	150	Ø40 / 1.575	75 / 2.952	96 / 3.780	Ø12 / 0.472	M6 x 1.0 x 16	UF0017	3	DB0007	26
UF1240	UF-FB-P-D040-L75	200									
UF1340	UF-FB-V-D040-L75	400									
UF1440	UF-FB-O-D040-L75	600									
UF1540	UF-FB-B-D040-L75	800									
UF1640	UF-FB-W-D040-L75	1000									
UF1740	UF-FB-R-D040-L75	1200									
UF1840	UF-FB-M-D040-L75	2000									
UF1940	UF-FB-Z-D040-L75	3000									
UF1040	UF-FB-A-D040-L75	6000									

UFIBER

SURFACE BRUSH

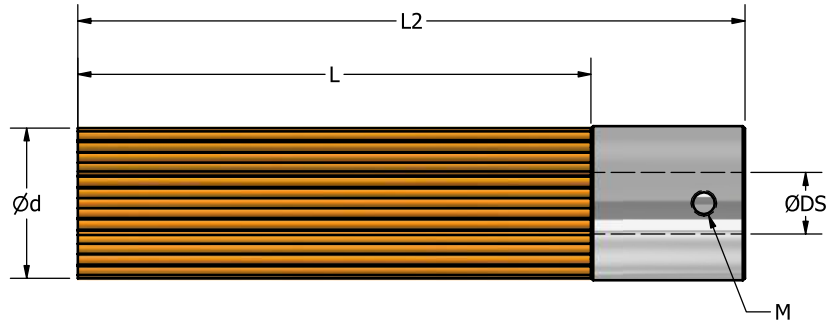

SKU	DESCRIPTION	GRIT SIZE	Ø d mm / inch	L mm / inch	L2 mm / inch	Ø DS mm / inch	SPARE PARTS ⁽¹⁾ (for M)				Wt. gram
							CLAMPING SCREW M x P x L (mm)	SKU	LN KEY L (mm)	SKU	
UF1160	UF-FB-G-D060-L75	150	Ø60 / 2.362	75 / 2.952	96 / 3.780	Ø13 / 0.512	M6 x 1.0 x 20	UF0016	3	DB0007	70
UF1260	UF-FB-P-D060-L75	200									
UF1360	UF-FB-V-D060-L75	400									
UF1460	UF-FB-O-D060-L75	600									
UF1560	UF-FB-B-D060-L75	800									
UF1660	UF-FB-W-D060-L75	1000									
UF1760	UF-FB-R-D060-L75	1200									
UF1860	UF-FB-M-D060-L75	2000									
UF1960	UF-FB-Z-D060-L75	3000									
UF1060	UF-FB-A-D060-L75	6000									
UF1100	UF-FB-G-D100-L75	150	Ø100 / 3.937	75 / 2.952	97 / 3.820	Ø16 / 0.630	M6 x 1.0 x 25	UF0015	3	DB0007	140
UF1200	UF-FB-P-D100-L75	200									
UF1300	UF-FB-V-D100-L75	400									
UF1400	UF-FB-O-D100-L75	600									
UF1500	UF-FB-B-D100-L75	800									
UF1600	UF-FB-W-D100-L75	1000									
UF1700	UF-FB-R-D100-L75	1200									
UF1800	UF-FB-M-D100-L75	2000									
UF1900	UF-FB-Z-D100-L75	3000									
UF1000	UF-FB-A-D100-L75	6000									

(1) The surface brush comes with 2 set-screws for mounting a shaft.
For more details, see "Versatile Surface Brush for Efficient
Cross-Hole Burr Removal" page 14.

SURFACE BRUSH SLEEVE

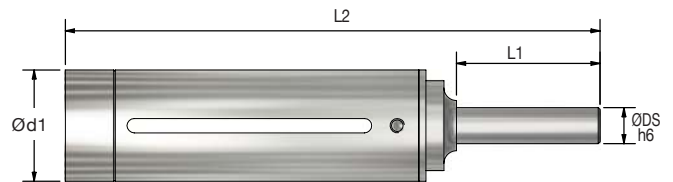

SKU	DESCRIPTION	SUITABLE FOR SURFACE BRUSH	Ø d1 mm / Inch	L1 mm / inch	L2 mm / inch	Ø DS mm / Inch	Wt. gram	SPARE PARTS (for M)			
								CLAMPING SCREW MxPxL (mm)	SKU	LN KEY L (mm)	SKU
UF5506	UF-FS-006-C06-L70	Ø 6/0.236	Ø 10.0/0.394	30/1.181	71/2.795	Ø 6/0.236	30	M3 x 0.5 x 4	UF0010	2.5	UF0021
UF5515	UF-FS-015-C06-L90	Ø 15/0.590	Ø 18.8/0.740	30/1.181	92/3.622	Ø 6/0.236	40	M3 x 0.5 x 6	UF0011	2	UF0020
UF5525	UF-FS-025-C10-L140	Ø 25/0.984	Ø 31.0/1.220	30/1.181	149/5.866	Ø 10/0.394	160	M4 x 0.7 x 10	UF0012	2.5	UF0021
UF5540	UF-FS-040-C12-L140	Ø 40/1.575	Ø 45.6/1.795	30/1.181	135/5.315	Ø 12/0.472	200	M6 x 1.0 x 10	UF0013	4	UF0022
UF5560	UF-FS-060-C12-L145	Ø 60/2.362	Ø 67.0/2.638	40/1.575	145/5.708	Ø 12/0.472	320	M6 x 1.0 x 10	UF0013	4	UF0022
UF5500	UF-FS-100-C16-L155	Ø 100/3.937	Ø 108.0/4.252	40/1.575	155/6.102	Ø 16/0.630	670	M8 x 1.25 x 16	UF0014	5	UF0023

UFIBER

SURFACE BRUSH SPEEDS AND FEEDS

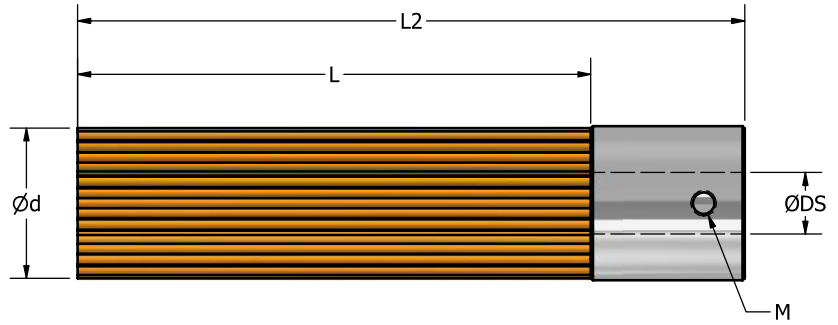

SUITABLE FOR SURFACE BRUSH mm/inch	ØDS mm/inch	L mm/inch	L2 mm/inch	DEPTH OF CUT (DOC)			REC. R.P.M.	FEED (max.) mm/min. Inch/min.	BRUSH PROJECTION ⁽¹⁾ (max.) mm/inch
				POLISHING mm / Inch	DEBURRING mm / Inch	MAX. mm / Inch			
Ø 6/0.236	NA	30/1.181	42.5/1.673	0.2/0.008	0.5/0.02	1.2/0.05	9000-12000	2000/79	10/0.394
Ø 15/0.590	Ø 6/0.236	50/1.969	65/2.559				5700-7200		
Ø 25/0.984	Ø 9/0.354	75/2.952	100/3.937				5000-6000		
Ø 40/1.575	Ø 12/0.472	75/2.952	96/3.780				2700-3600		
Ø 60/2.362	Ø 13/0.512	75/2.952	96/3.780				1800-2400		
Ø 100/3.937	Ø 16/0.630	75/2.952	97/3.820				1000-1400		

⁽¹⁾When mounted with corresponding sleeve

UFIBER

SURFACE BRUSH

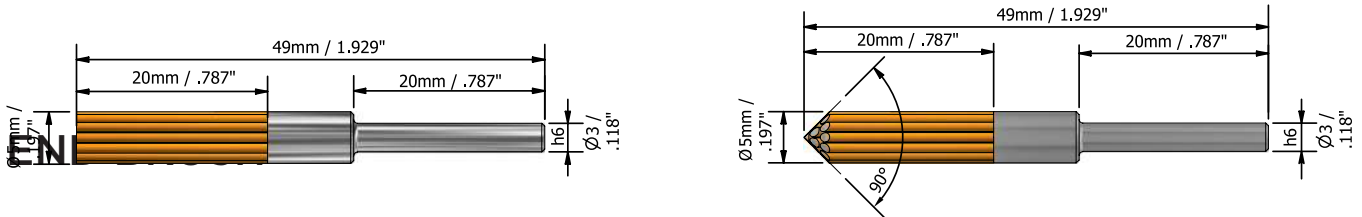

FLAT END BRUSH				
SKU	DESCRIPTION	GRIT SIZE	Wt. gram	MAX. RPM ⁽¹⁾
UF4150	UF-EB-G-D5-L20	150	3	12000
UF4250	UF-EB-P-D5-L20	200		
UF4350	UF-EB-V-D5-L20	400		
UF4450	UF-EB-O-D5-L20	600		
UF4550	UF-EB-B-D5-L20	800		
UF4650	UF-EB-W-D5-L20	1000		
UF4750	UF-EB-R-D5-L20	1200		
UF4850	UF-EB-M-D5-L20	2000		
UF4950	UF-EB-Z-D5-L20	3000		
UF4050	UF-EB-A-D5-L20	6000		

90° ANGLED END BRUSH				
SKU	DESCRIPTION	GRIT SIZE	Wt. gram	MAX. RPM ⁽¹⁾
UF6150	UF-EB45-G-D5-L20	150	3	12000
UF6250	UF-EB45-P-D5-L20	200		
UF6350	UF-EB45-V-D5-L20	400		
UF6450	UF-EB45-O-D5-L20	600		
UF6550	UF-EB45-B-D5-L20	800		
UF6650	UF-EB45-W-D5-L20	1000		
UF6750	UF-EB45-R-D5-L20	1200		
UF6850	UF-EB45-M-D5-L20	2000		
UF6950	UF-EB45-Z-D5-L20	3000		
UF6050	UF-EB45-A-D5-L20	6000		

⁽¹⁾The brush bristles will maintain their original shape at maximum RPM.

UFIBER

POINT BRUSH

Dimensions for 1.0 - 2.0mm (0.039 - 0.079")

SKU	DESCRIPTION	GRIT SIZE	Ø d mm / inch	Wt. gram	MAX. RPM ⁽¹⁾
UF3110	UF-PB-G-D1-L20	150	Ø1.0 / 0.039	2	12000
UF3210	UF-PB-P-D1-L20	200			
UF3310	UF-PB-V-D1-L20	400			
UF3410	UF-PB-O-D1-L20	600			
UF3510	UF-PB-B-D1-L20	800			
UF3610	UF-PB-W-D1-L20	1000			
UF3710	UF-PB-R-D1-L20	1200			
UF3810	UF-PB-M-D1-L20	2000			
UF3910	UF-PB-Z-D1-L20	3000			
UF3010	UF-PB-A-D1-L20	6000			
UF3115	UF-PB-G-D1.5-L20	150			
UF3215	UF-PB-P-D1.5-L20	200			
UF3315	UF-PB-V-D1.5-L20	400			
UF3415	UF-PB-O-D1.5-L20	600			
UF3515	UF-PB-B-D1.5-L20	800			
UF3615	UF-PB-W-D1.5-L20	1000			
UF3715	UF-PB-R-D1.5-L20	1200			
UF3815	UF-PB-M-D1.5-L20	2000			
UF3915	UF-PB-Z-D1.5-L20	3000			
UF3015	UF-PB-A-D1.5-L20	6000			
UF3120	UF-PB-G-D2-L20	150	Ø2.0 / 0.079	2	12000
UF3220	UF-PB-P-D2-L20	200			
UF3320	UF-PB-V-D2-L20	400			
UF3420	UF-PB-O-D2-L20	600			
UF3520	UF-PB-B-D2-L20	800			
UF3620	UF-PB-W-D2-L20	1000			
UF3720	UF-PB-R-D2-L20	1200			
UF3820	UF-PB-M-D2-L20	2000			
UF3920	UF-PB-Z-D2-L20	3000			
UF3020	UF-PB-A-D2-L20	6000			

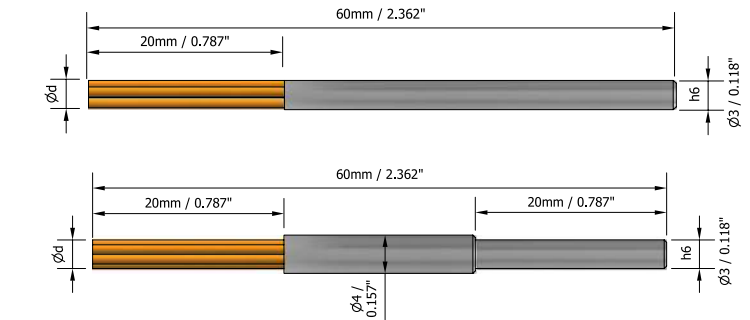

Dimensions only for 2.5 - 3mm (0.098 - 0.118")

SKU	DESCRIPTION	GRIT SIZE	Ø d mm / inch	Wt. gram	MAX. RPM ⁽¹⁾
UF3125	UF-PB-G-D2.5-L20	150	Ø2.5 / 0.098	3	12000
UF3225	UF-PB-P-D2.5-L20	200			
UF3325	UF-PB-V-D2.5-L20	400			
UF3425	UF-PB-O-D2.5-L20	600			
UF3525	UF-PB-B-D2.5-L20	800			
UF3625	UF-PB-W-D2.5-L20	1000			
UF3725	UF-PB-R-D2.5-L20	1200			
UF3825	UF-PB-M-D2.5-L20	2000			
UF3925	UF-PB-Z-D2.5-L20	3000			
UF3025	UF-PB-A-D2.5-L20	6000			
UF3130	UF-PB-G-D3-L20	150			
UF3230	UF-PB-P-D3-L20	200			
UF3330	UF-PB-V-D3-L20	400			
UF3430	UF-PB-O-D3-L20	600			
UF3530	UF-PB-B-D3-L20	800			
UF3630	UF-PB-W-D3-L20	1000			
UF3730	UF-PB-R-D3-L20	1200			
UF3830	UF-PB-M-D3-L20	2000			
UF3930	UF-PB-Z-D3-L20	3000			
UF3030	UF-PB-A-D3-L20	6000			

⁽¹⁾The brush bristles will maintain their original shape at maximum RPM.



For additional details about our UFIBER products, including the complete product range and technical guidelines, please visit our website at: <https://nogamt.com/ufiber-ceramic-brush/>

ULTIMATE UBACK! TOOLS

PRECISION BACK COUNTER SOLUTIONS



The Ultimate Back line brings together the innovative **UX** Tool-holders and **USPOT** & **UCHAMF** inserts to redefine machining precision. Featuring a patented hydraulic mechanism that ingeniously uses the machine's coolant liquid, this system delivers exceptional control over insert movement.

THE RESULT - Unparalleled accuracy, repeatability, and streamlined operations for back counterboring, back countersinking, and back spotfacing tasks.

ULTIMATE UBACK! TOOLS

PRECISION BACK COUNTER SOLUTIONS

NOGA MT's Ultimate Back series combines innovative **UX** Tool-holders with **USPOT** & **UCHAMF** inserts to deliver unparalleled precision in back spotfacing, back counterboring, and back countersinking operations. This system utilizes a registered patented hydraulic mechanism operated by the CNC machine's coolant, ensuring exceptional control over insert movement for accurate and repeatable machining which optimizes machining processes and reduces cycle times. Its advanced engineering ensures flawless results, making it the ultimate choice for professionals seeking precision and efficiency in their machining operations.

UBACK

Tool Holders Support Pilot Hole Diameters $\varnothing d$
Ranging from $\varnothing 8.0$ - 25.0 mm (0.315 - 0.984 "")

USPOT Inserts



Through-hole Back Counterboring or Spotfacing

Spotface Diameters from $\varnothing 8.5$ - 57.5 mm (0.335 - 2.264 "")
Semi-Standard or Tailor-made Inserts

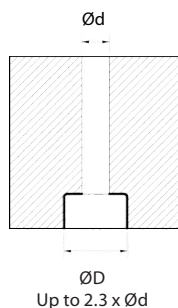

UCHAMF Inserts



Through-hole Back Chamfering

Countersink Diameters from $\varnothing 8.5$ - 46.0 mm (0.335 - 1.811 "")
Available with Standard 82° and 90° Countersink Inserts

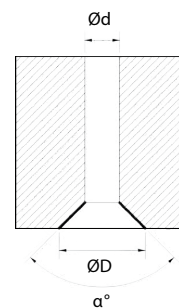

ULTIMATE UBACK! TOOLS

UBACK MAIN BENEFITS

OPERATIONAL

- Single-pass operation without workpiece rotation.
- Superior chip management.
- Streamlined insert replacement.
- Protected pilot hole integrity.

PRODUCTION

- **SolidCAM Ready:** The UBACK tool-holders are included in SolidCAM libraries, providing quick access to specifications and applications for seamless integration. This simplifies programming, reduces cycle times and enhances overall efficiency.



- Automation-compatible design for optimizing efficiency.
- Cost-effective for all production volumes.

INDUSTRIAL APPLICATIONS

- Aerospace
- Automotive
- Medical
- Electronics



UBACK

MAIN BENEFITS

Our patented hydraulic mechanism harnesses your machine's coolant liquid to deliver precise control over insert movement, ensuring exceptional accuracy and repeatability in:

BACK COUNTERBORING AND SPOTFACING

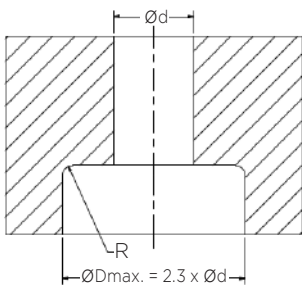

BACK COUNTERSINKING AND CHAMFERING

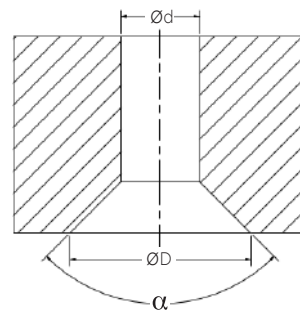

UBACK TOOL-HOLDERS FEATURES

- Innovative hydraulic coolant-powered precision control mechanism for controlling the insert retraction into the tool-holder body.
- Minimum pressure requirement: 20 bar / 300 PSI.
- Compatible to work with air, emulsion or MQL.
- Diameter range: $\varnothing 8$ mm to $\varnothing 25$ mm (0.315 - 0.984") with increments of 1 mm (0.039").
- Superior chip-control with coolant directed to the cutting edge.
- Compatible for both USPOT or UCHAMF inserts.

USPOT & UCHAMF INSERTS FEATURES

- High accuracy and reparability due to advanced production process.
- The USPOT inserts can reach up to 2.3 from the pilot-hole diameter.
- Specialized designs for specific machining operations.
- Easy single-screw replacement.
- Various coating options available.
- Customizable chip-formers and corner radii.
- Protective pilot hole design preventing scratches.

UBACK

HOW DOES UBACK WORK?

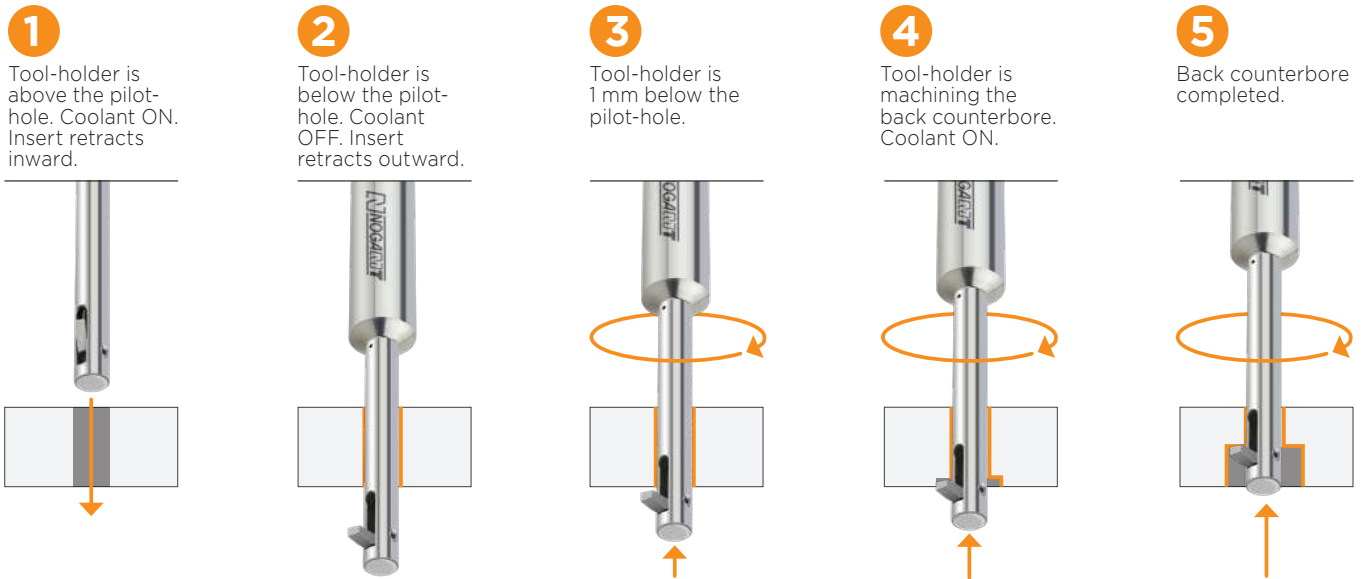

COMPARATIVE ANALYSIS

FEATURE	UBACK by NOGAMT	COMPETITOR "X"
TECHNOLOGY	Hydraulic mechanism for precise control	Mechanical and hydraulic mechanism
APPLICATIONS	Back spotfacing, counterboring, countersinking, including interrupted cut applications	Back spotfacing, counterboring, with limited interrupted cut applications
MATERIAL SUITABILITY	Compatible with all materials; offers advanced coatings and chip-formers (e.g. hardened steel, composites).	Limited materials; fewer coatings and chip-formers
AUTOMATION READINESS	Fully compatible with CNC and robotic systems	Limited CNC integration
INSERT RETRACTION	Precise hydraulic actuation	Controlled with hydraulic actuation
INSERT EXTENSION	Precise hydraulic actuation	Uses centrifugal force
COOLANT SYSTEM	Same tool-holder works for air, emulsion or MQL	Requires a different tool-holder system
SPEED & EFFICIENCY	Delivers faster cycle times and high repeatability	Standard operational speed
CHIP CONTROL	Advanced chip-formers and optimized coating for better control	Basic chip evacuation system
INSERT REPLACEMENT	Easy replacement with a single screw, no additional tools needed	Requires replacement pins and special mounting devices

VALUE PROPOSITION

The **UBACK** by NOGAMT redefines back machining with its combination of precision engineering and operational efficiency. Its innovative design enhances machining processes, ensuring consistent, high-quality results, while minimizing operational costs and maximizing productivity. This makes it the ideal solution for advanced manufacturing, excelling in precision, speed and material versatility.

UBACK USPOT INSERT

SERIES AND RANGE

The **UBACK** line is divided into series or groups, with each series optimized for a specific pilot-hole range and determined by the type of insert family.

For **USPOT** inserts:

SERIES	Ød PILOT-HOLE RANGE mm / Inch	ØD COUNTERBORE RANGE mm / Inch
B	8.0 -10.0 / 0.315 - 0.394	8.5 -23.0 / 0.335 - 0.906
C	11.0 -13.0 / 0.433 - 0.512	11.5 - 30.0 / 0.453 - 1.181
D	14.0 -16.0 / 0.551 - 0.630	14.5 -37.0 / 0.571 - 1.457
E	17.0 -19.0 / 0.669 - 0.748	17.5 -44.0 / 0.689 - 1.732
F	20.0 -22.0 / 0.787 - 0.866	20.5 -50.5 / 0.807 - 1.988
G	23.0 -25.0 / 0.906 - 0.984	23.5 -57.5 / 0.925 - 2.264

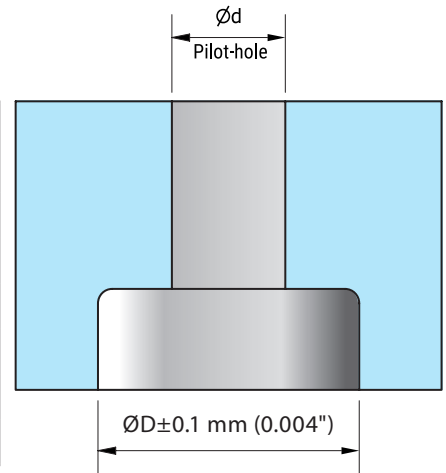

The **USPOT inserts** are offered as semi-standard solutions tailored to meet customer-specific applications. It is mandatory to match the tool-holder series with the corresponding insert series.

USPOT INSERTS CODING SYSTEM SPECIFICATIONS AND IDENTIFICATION:

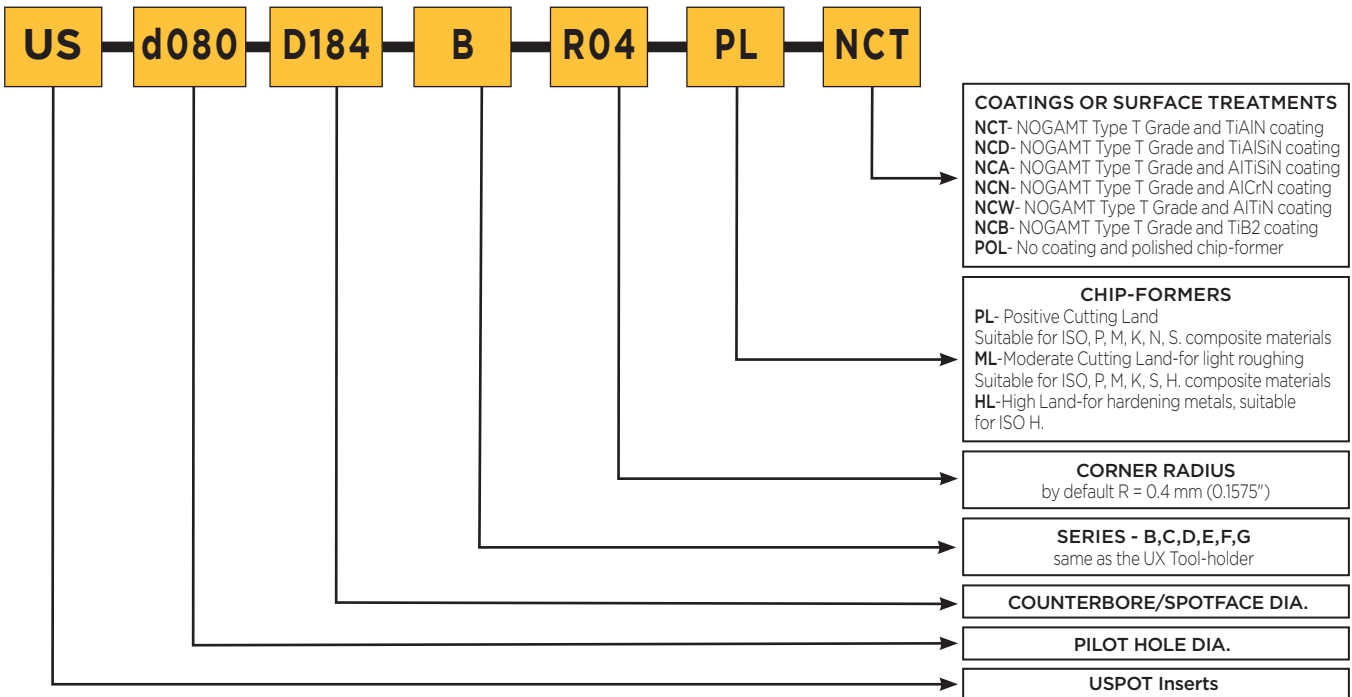

NOTES:

- Coating:** Our top recommendation is the NCT grade, featuring the versatile TiAlN PVD coating. It offers excellent thermal stability, oxidation resistance, and is compatible with a wide range of materials, including mild steels, stainless steel, and Inconel. For additional options, refer to the list of available coatings on page 37.
- Tool-holders and inserts** are sold separately.

UBACK USPOT INSERT

HOW TO ORDER A USPOT INSERT TO MATCH YOUR APPLICATION

The **USPOT** inserts are available only as semi-standard solutions tailored to customer applications.

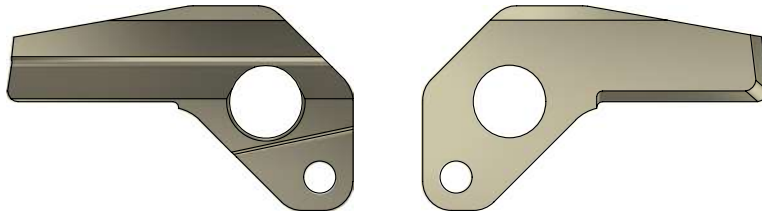

- **CHOOSE THE APPROPRIATE TOOL-HOLDER BASED ON THE PILOT HOLE DIAMETER.**
For instance, if the pilot hole diameter is 8.5 mm, select the **UX2080**, which supports a minimum diameter (\varnothing_{dmin}) of 8 mm.
- **SPECIFY THE REQUIRED PARAMETERS FOR THE USPOT INSERT**, including the pilot-hole diameter, counter-bore or spotface diameter, corner radius, chip-former and coating according to coding system page 26.
- **FILL IN THE RELEVANT DETAILS FOR THE USPOT INSERT** description as outlined in the coding system below.
- **ENSURE COMPATIBILITY BETWEEN THE USPOT INSERT SERIES AND THE CORRESPONDING UX TOOL-HOLDER.** The series of the insert must match the series of the **UX** tool-holder.

USPOT - EXAMPLE FOR ORDERING SEMI-STANDARD INSERT:

Here is an example of coding a semi-standard **USPOT** insert for the application shown below:

1. $\varnothing d$ = 8.7mm (0.343")
2. $\varnothing D$ = 17.6mm (0.693")
3. R = 0.2mm (0.032")
4. **Material:** AISI 4340 / 34CrNiMo6 (1.6582) / SNCM439, tempered to 42 HR

The recommended tool-holder is **UX2080 / UX-d080-B-C16-H62-L115**.

The corresponding insert is **US-d087-D176-B-R02-ML-NCT**

IMPORTANT NOTES:

Ensure that the pilot-hole length (L) is less than or equal to the RFC (Relief For Cutting) $L \leq RFC$, as specified in the UBACK tool-holders table pages 28-29.

If you need further assistance, please don't hesitate to contact us: Providing an application drawing or sketch, the raw material specifications, and any other relevant information will help us assist you more effectively.

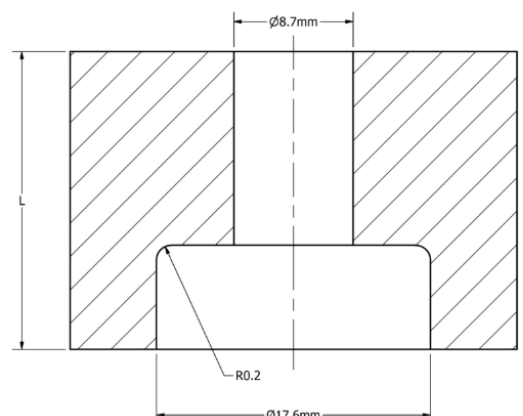

UBACK

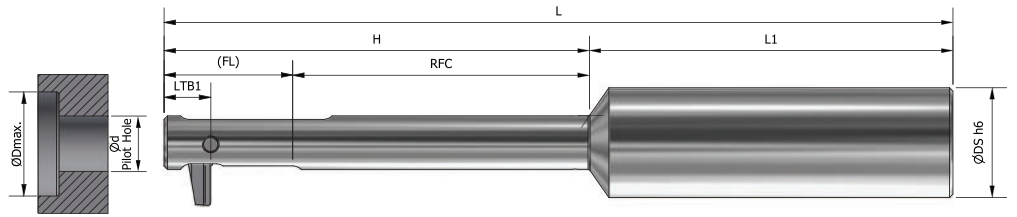

STANDARD TOOL-HOLDERS WITH USPOT INSERTS (mm)

Ød min. PILOT HOLE	SKU TOOL-HOLDER	DESCRIPTION TOOL-HOLDER	ØDS h6	FL ⁽¹⁾	RFC ⁽²⁾	H	L	L1	LTB1 ⁽³⁾ USPOT	ØD ⁽⁴⁾ max.	INSERTING CLAMPING SCREW MxPxL (mm)	SERIES ⁽⁵⁾
8	UX2080	UX-d080-B-C16-H62-L115	16	17	43	62	115	53	6.8	18.5	UX0005/ M2.5x0.35x7B	B
9	UX2090	UX-d090-B-C16-H62-L115	16	17.8	43	62	115	53	6.8	21		B
10	UX2100	UX-d100-B-C16-H62-L115	16	18.8	43	62	115	53	6.8	23		B
11	UX3110	UX-d110-C-C16-H80-L133	16	27	52	80	133	53	11.4	26	UX0006/ M3x0.35x10C	C
12	UX3120	UX-d120-C-C16-H80-L133	16	27.3	52	80	133	53	11.4	28		C
13	UX3130	UX-d130-C-C16-H80-L133	16	28	52	80	133	53	11.4	30		C
14	UX4140	UX-d140-D-C20-H105-L158	20	32.5	72.5	105	158	53	13.5	32.5	UX0007/ M3x0.35x13D	D
15	UX4150	UX-d150-D-C20-H105-L158	20	32.5	72.5	105	158	53	13.5	34.5		D
16	UX4160	UX-d160-D-C20-H105-L158	20	32.5	72.5	105	158	53	13.5	37		D
17	UX5170	UX-d170-E-C20-H115-L170	20	38.5	76.5	115	170	55	16	39.5	UX0008/ M3x0.35x16E	E
18	UX5180	UX-d180-E-C20-H115-L170	20	38.5	76.5	115	170	55	16	41.5		E
19	UX5190	UX-d190-E-C20-H115-L170	20	38.5	76.5	115	170	55	16	44		E
20	UX6200	UX-d200-F-C25-H120-L175	25	43.5	76.5	120	175	55	17.8	46	UX0009/ M4x0.5x19F	F
21	UX6210	UX-d210-F-C25-H120-L175	25	43.5	76.5	120	175	55	17.8	48.5		F
22	UX6220	UX-d220-F-C25-H120-L175	25	43.5	76.5	120	175	55	17.8	50.5		F
23	UX7230	UX-d230-G-C25-H120-L175	25	48	72	120	175	55	20	53	UX0010/ M4x0.5x21G	G
24	UX7240	UX-d240-G-C25-H120-L175	25	48	72	120	175	55	20	55.5		G
25	UX7250	UX-d250-G-C25-H120-L175	25	48	72	120	175	55	20	57.5		G

(1) **FL** - Folding Length.

(2) **RFC** - Relief For Cutting.



(3) **LTB** (Length to bottom) parameter varies between **USPOT** and **UCHAMF** inserts.

(4) The achieved tolerance for the counterbore or spotface diameter ØD is ±0.1 mm (0.004").

(5) The insert series must match the series of the tool-holder.

NOTE Tool-holders and inserts are sold separately.

UX Tool-holder Spare Parts:

-  Hex L-Key - SP0105 0.050" 1 + 1/16 /1 + 9/16
-  Insert Clamping Screw - according to the table above.
-  Pin - UX0003

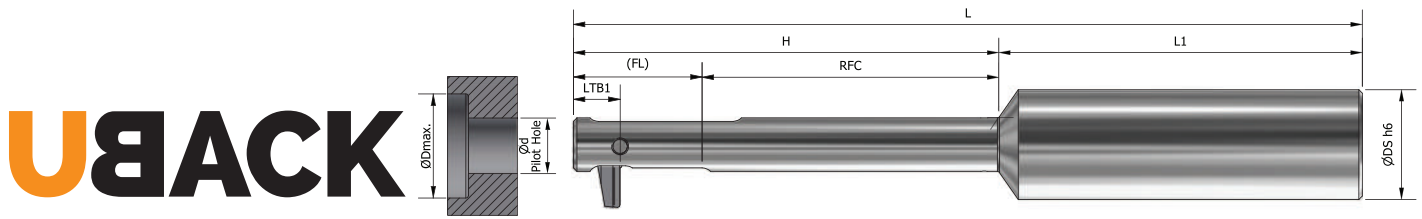

STANDARD TOOL-HOLDERS WITH USPOT INSERTS (Inch)

Ød min. PILOT HOLE	SKU TOOL-HOLDER	DESCRIPTION TOOL-HOLDER	ØDS h6	FL ⁽¹⁾	RFC ⁽²⁾	H	L	L1	LTB1 ⁽³⁾ USPOT	ØD ⁽⁴⁾ max.	INSERTING CLAMPING SCREW MxPxL (mm)	SERIES ⁽⁵⁾
0.315	UX2080	UX-d080-B-C16-H62-L115	0.630	0.669	1.693	2.441	4.528	2.087	0.268	0.728	UX0005/ M2.5x0.35x7B	B
0.354	UX2090	UX-d090-B-C16-H62-L115	0.630	0.701	1.693	2.441	4.528	2.087	0.268	0.827		B
0.394	UX2100	UX-d100-B-C16-H62-L115	0.630	0.740	1.693	2.441	4.528	2.087	0.268	0.906		B
0.433	UX3110	UX-d110-C-C16-H80-L133	0.630	1.063	2.047	3.150	5.236	2.087	0.449	1.024	UX0006/ M3x0.35x10C	C
0.472	UX3120	UX-d120-C-C16-H80-L133	0.630	1.075	2.047	3.150	5.236	2.087	0.449	1.102		C
0.512	UX3130	UX-d130-C-C16-H80-L133	0.630	1.102	2.047	3.150	5.236	2.087	0.449	1.181		C
0.551	UX4140	UX-d140-D-C20-H105-L158	0.787	1.280	2.854	4.134	6.220	2.087	0.531	1.280	UX0007/ M3x0.35x13D	D
0.591	UX4150	UX-d150-D-C20-H105-L158	0.787	1.280	2.854	4.134	6.220	2.087	0.531	1.358		D
0.630	UX4160	UX-d160-D-C20-H105-L158	0.787	1.280	2.854	4.134	6.220	2.087	0.531	1.457		D
0.669	UX5170	UX-d170-E-C20-H115-L170	0.787	1.516	3.012	4.528	6.693	2.165	0.630	1.555	UX0008/ M3x0.35x16E	E
0.709	UX5180	UX-d180-E-C20-H115-L170	0.787	1.516	3.012	4.528	6.693	2.165	0.630	1.634		E
0.748	UX5190	UX-d190-E-C20-H115-L170	0.787	1.516	3.012	4.528	6.693	2.165	0.630	1.732		E
0.787	UX6200	UX-d200-F-C25-H120-L175	0.984	1.713	3.012	4.724	6.890	2.165	0.701	1.811	UX0009/ M4x0.5x19F	F
0.827	UX6210	UX-d210-F-C25-H120-L175	0.984	1.713	3.012	4.724	6.890	2.165	0.701	1.909		F
0.866	UX6220	UX-d220-F-C25-H120-L175	0.984	1.713	3.012	4.724	6.890	2.165	0.701	1.988		F
0.906	UX7230	UX-d230-G-C25-H120-L175	0.984	1.890	2.835	4.724	6.890	2.165	0.787	2.087	UX0010/ M4x0.5x21G	G
0.945	UX7240	UX-d240-G-C25-H120-L175	0.984	1.890	2.835	4.724	6.890	2.165	0.787	2.185		G
0.984	UX7250	UX-d250-G-C25-H120-L175	0.984	1.890	2.835	4.724	6.890	2.165	0.787	2.264		G

(1) FL - Folding Length.

(2) RFC - Relief For Cutting.



(3) LTB (Length to bottom) parameter varies between **USPOT** and **UCHAMF** inserts.

(4) The achieved tolerance for the counterbore or spotface diameter ØD is ±0.1 mm (0.004").

(5) The insert series must match the series of the tool-holder.

NOTE Tool-holders and inserts are sold separately.

UX Tool-holder Spare Parts:

-  Hex L-Key - SP0105 0.050" 1 + 1/16 /1 + 9/16
-  Insert Clamping Screw - according to the table above.
-  Pin - UX0003

UBACK UCHAMF INSERT

SERIES AND RANGE

The **UBACK** line is divided into series or groups, with each series optimized for a specific pilot-hole range and determined by the type of insert family.

For **UCHAMF** inserts:

SERIES	Ød PILOT-HOLE RANGE mm / Inch	ØD COUNTERSINK RANGE for 82° mm / Inch	ØD COUNTERSINK RANGE for 90° mm / Inch
B	8.0-10.0 / 0.315-0.394	8.5-20.0 / 0.335 - 0.787	8.5-19.0 / 0.335 - 0.748
C	11.0-13.0 / 0.433-0.512	11.5-28.0 / 0.453-1.102	11.5-26.0 / 0.453-1.024
D	14.0-16.0 / 0.551-0.630	14.5-34.0 / 0.571-1.339	14.5-31.0 / 0.571-1.220
E	17.0-19.0 / 0.669-0.748	17.5-40.0 / 0.689-1.575	17.5-37.0 / 0.689-1.457
F	20.0-22.0 / 0.787-0.866	20.5-43.0 / 0.807-1.693	20.5-40.0 / 0.807-1.575
G	23.0-25.0 / 0.906-0.984	23.5-46.0 / 0.925-1.811	23.5-43.0 / 0.925-1.693

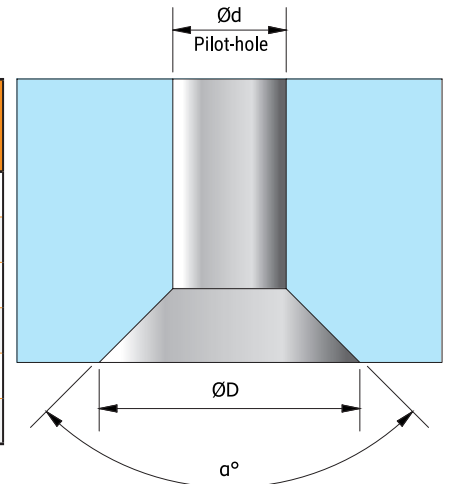

■ The **UCHAMF inserts** are offered as standard (82°, 90° countersink angles) or semi-standard solutions tailored to meet customer-specific applications. It is mandatory to match the tool-holder series with the corresponding insert series.

UCHAMF INSERTS CODING SYSTEM SPECIFICATIONS AND IDENTIFICATION:

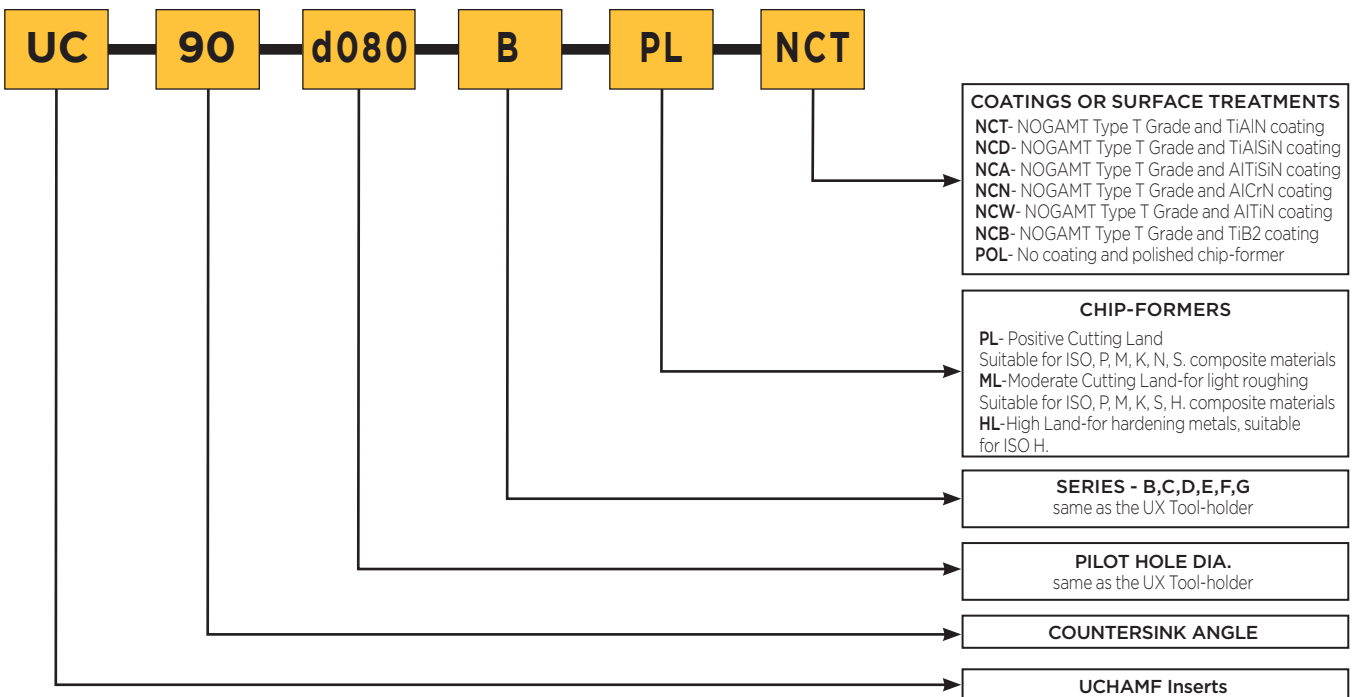

NOTES:

1. Coating: Our top recommendation is the NCT grade, featuring the versatile TiAlN PVD coating. It offers excellent thermal stability, oxidation resistance and is compatible with a wide range of materials, including mild steels, stainless steel, and Inconel. For additional options, refer to the list of available coatings on page 37.

2. Tool-holders and inserts are sold separately.

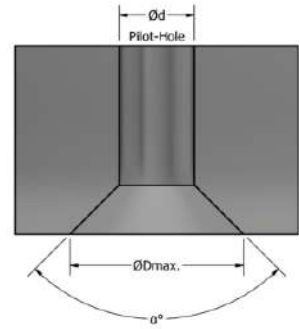

UCHAMF 82° and 90° STANDARD INSERTS (mm/Inch)

Ødmin. PILOT HOLE mm /Inch	COUNTERSINK ANGLE $\alpha = 82^\circ$			COUNTERSINK ANGLE $\alpha = 90^\circ$			SERIES
	SKU	DESCRIPTION	Ø D MAX. mm /Inch	SKU	DESCRIPTION	Ø D MAX. mm /Inch	
8/0.315	UC2101	UC-82-d080-B-PL-NCT	18/0.709	UC2201	UC-90-d080-B-PL-NCT	17/0.669	B
9/0.354	UC2102	UC-82-d090-B-PL-NCT	19/0.748	UC2202	UC-90-d090-B-PL-NCT	18/0.709	
10/0.394	UC2103	UC-82-d100-B-PL-NCT	20/0.787	UC2203	UC-90-d100-B-PL-NCT	19/0.748	
11/0.433	UC3101	UC-82-d110-C-PL-NCT	26/1.024	UC3201	UC-90-d110-C-PL-NCT	24/0.945	C
12/0.472	UC3102	UC-82-d120-C-PL-NCT	27/1.063	UC3202	UC-90-d120-C-PL-NCT	25/0.948	
13/0.512	UC3103	UC-82-d130-C-PL-NCT	28/1.102	UC3203	UC-90-d130-C-PL-NCT	26/1.024	
14/0.551	UC4101	UC-82-d140-D-PL-NCT	31/1.220	UC4201	UC-90-d140-D-PL-NCT	28/1.102	D
15/0.591	UC4102	UC-82-d150-D-PL-NCT	32/1.260	UC4202	UC-90-d150-D-PL-NCT	29/1.142	
16/0.630	UC4103	UC-82-d160-D-PL-NCT	34/1.339	UC4203	UC-90-d160-D-PL-NCT	31/1.220	
17/0.669	UC5101	UC-82-d170-E-PL-NCT	37/1.457	UC5201	UC-90-d170-E-PL-NCT	34/1.339	E
18/0.709	UC5102	UC-82-d180-E-PL-NCT	38/1.496	UC5202	UC-90-d180-E-PL-NCT	35/1.378	
19/0.748	UC5103	UC-82-d190-E-PL-NCT	40/1.575	UC5203	UC-90-d190-E-PL-NCT	37/1.457	
20/0.787	UC6101	UC-82-d200-F-PL-NCT	41/1.614	UC6201	UC-90-d200-F-PL-NCT	38/1.496	F
21/0.827	UC6102	UC-82-d210-F-PL-NCT	42/1.654	UC6202	UC-90-d210-F-PL-NCT	39/1.535	
22/0.866	UC6103	UC-82-d220-F-PL-NCT	43/1.693	UC6203	UC-90-d220-F-PL-NCT	40/1.575	
23/0.906	UC7101	UC-82-d230-G-PL-NCT	44/1.732	UC7201	UC-90-d230-G-PL-NCT	41/1.614	G
24/0.945	UC7102	UC-82-d240-G-PL-NCT	45/1.772	UC7202	UC-90-d240-G-PL-NCT	42/1.654	
25/0.984	UC7103	UC-82-d250-G-PL-NCT	46/1.811	UC7203	UC-90-d250-G-PL-NCT	43/1.693	

UCHAMF - EXAMPLE FOR ORDERING SEMI-STANDARD INSERT:

Here is an example of coding a special **UCHAMF** insert for the application shown below:

1. **Ød** = 8.7mm (0.343").
2. **Countersink Angle** = 110°.
3. **Material:** AISI / EN AW / JIS - 7075.

The recommended tool-holder is **UX2080 / UX-d080-B-C16-H62-L115** with **Ød_{min}** = 8mm (0.315").

The corresponding insert is **UC-110-d080-B-PL-NCT**.

IMPORTANT NOTES:

1. Ensure that the pilot-hole length (L) is less than or equal to the RFC (Relief For Cutting): $L \leq RFC$, as specified in the UBACK tool-holders table below.
2. Ensure that the countersink diameter **ØD** is less than or equal to the maximum allowable diameter: $\text{ØD} \leq \text{ØD}_{\text{max}}$, as specified in the UBACK tool-holders table pages 32-33.

If you need further assistance, please don't hesitate to contact us: Providing an application drawing or sketch, the raw material specifications, and any other relevant information will help us assist you more effectively.

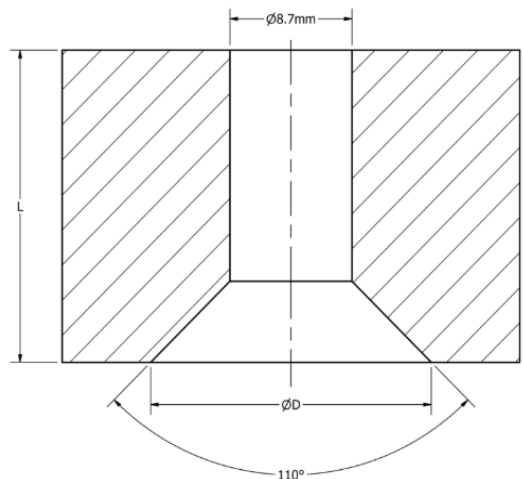

UBACK

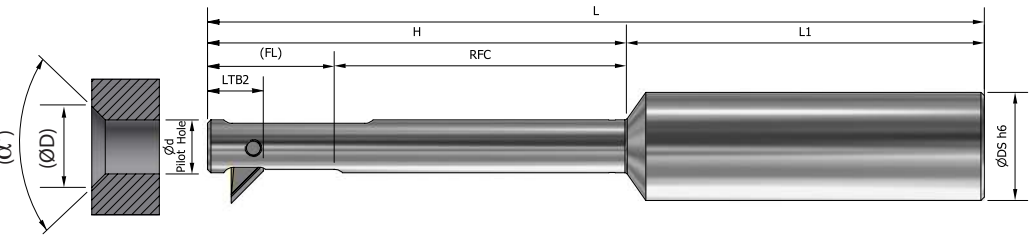

STANDARD TOOL-HOLDERS WITH UCHAMF INSERTS (mm)

∅d min. PILOT HOLE	SKU TOOL-HOLDER	DESCRIPTION TOOL-HOLDER	∅DS h6	FL ⁽¹⁾	RFC ⁽²⁾	H	L	L1	LTB2 ⁽³⁾ UCHAMF	INSERTING CLAMPING SCREW MxPxL (mm)	SERIES ⁽⁴⁾
8	UX2080	UX-d080-B-C16-H62-L115	16	17	43	62	115	53	8.25	UX0005/ M2.5x0.35x7B	B
9	UX2090	UX-d090-B-C16-H62-L115	16	17.8	43	62	115	53	8.25		B
10	UX2100	UX-d100-B-C16-H62-L115	16	18.8	43	62	115	53	8.25		B
11	UX3110	UX-d110-C-C16-H80-L133	16	27	52	80	133	53	13.6	UX0006/ M3x0.35x10C	C
12	UX3120	UX-d120-C-C16-H80-L133	16	27.3	52	80	133	53	13.6		C
13	UX3130	UX-d130-C-C16-H80-L133	16	28	52	80	133	53	13.6		C
14	UX4140	UX-d140-D-C20-H105-L158	20	32.5	72.5	105	158	53	15.3	UX0007/ M3x0.35x13D	D
15	UX4150	UX-d150-D-C20-H105-L158	20	32.5	72.5	105	158	53	15.3		D
16	UX4160	UX-d160-D-C20-H105-L158	20	32.5	72.5	105	158	53	15.3		D
17	UX5170	UX-d170-E-C20-H115-L170	20	38.5	76.5	115	170	55	18	UX0008/ M3x0.35x16E	E
18	UX5180	UX-d180-E-C20-H115-L170	20	38.5	76.5	115	170	55	18		E
19	UX5190	UX-d190-E-C20-H115-L170	20	38.5	76.5	115	170	55	18		E
20	UX6200	UX-d200-F-C25-H120-L175	25	43.5	76.5	120	175	55	20	UX0009/ M4x0.5x19F	F
21	UX6210	UX-d210-F-C25-H120-L175	25	43.5	76.5	120	175	55	20		F
22	UX6220	UX-d220-F-C25-H120-L175	25	43.5	76.5	120	175	55	20		F
23	UX7230	UX-d230-G-C25-H120-L175	25	48	72	120	175	55	22	UX0010/ M4x0.5x21G	G
24	UX7240	UX-d240-G-C25-H120-L175	25	48	72	120	175	55	22		G
25	UX7250	UX-d250-G-C25-H120-L175	25	48	72	120	175	55	22		G

(1) FL - Folding Length.



(2) RFC - Relief For Cutting.

(3) LTB (Length to bottom) parameter varies between **USPOT** and **UCHAMF** inserts.

(4) The insert series must match the series of the tool-holder.

NOTE Tool-holders and inserts are sold separately.

UX Tool-holder Spare Parts:

-  Hex L-Key - SP0105 0.050" 1 + 1/16 /1 + 9/16
-  Insert Clamping Screw - according to the table above.
-  Pin - UX0003

UBACK

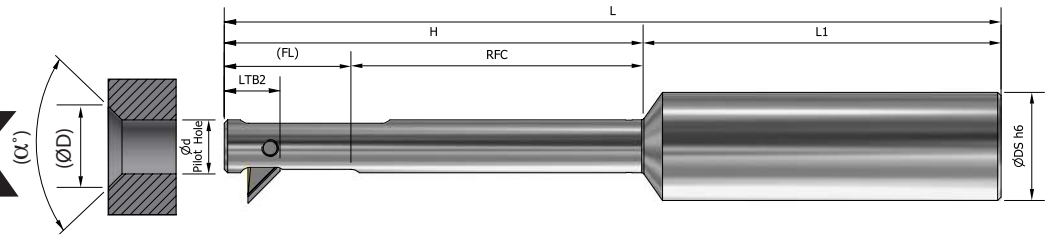

STANDARD TOOL-HOLDERS WITH UCHAMF INSERTS (Inch)

∅d min. PILOT HOLE	SKU TOOL-HOLDER	DESCRIPTION TOOL-HOLDER	∅DS h6	FL ⁽¹⁾	RFC ⁽²⁾	H	L	L1	LTB2 ⁽³⁾ UCHAMF	INSERTING CLAMPING SCREW MxPxL (mm)	SERIES ⁽⁴⁾
0.315	UX2080	UX-d080-B-C16-H62-L115	0.630	0.669	1.693	2.441	4.528	2.087	0.325	UX0005/ M2.5x0.35x7B	B
0.354	UX2090	UX-d090-B-C16-H62-L115	0.630	0.701	1.693	2.441	4.528	2.087	0.325		B
0.394	UX2100	UX-d100-B-C16-H62-L115	0.630	0.740	1.693	2.441	4.528	2.087	0.325		B
0.433	UX3110	UX-d110-C-C16-H80-L133	0.630	1.063	2.047	3.150	5.236	2.087	0.535	UX0006/ M3x0.35x10C	C
0.472	UX3120	UX-d120-C-C16-H80-L133	0.630	1.075	2.047	3.150	5.236	2.087	0.535		C
0.512	UX3130	UX-d130-C-C16-H80-L133	0.630	1.102	2.047	3.150	5.236	2.087	0.535		C
0.551	UX4140	UX-d140-D-C20-H105-L158	0.787	1.280	2.854	4.134	6.220	2.087	0.602	UX0007/ M3x0.35x13D	D
0.591	UX4150	UX-d150-D-C20-H105-L158	0.787	1.280	2.854	4.134	6.220	2.087	0.602		D
0.630	UX4160	UX-d160-D-C20-H105-L158	0.787	1.280	2.854	4.134	6.220	2.087	0.602		D
0.669	UX5170	UX-d170-E-C20-H115-L170	0.787	1.516	3.012	4.528	6.693	2.165	0.709	UX0008/ M3x0.35x16E	E
0.709	UX5180	UX-d180-E-C20-H115-L170	0.787	1.516	3.012	4.528	6.693	2.165	0.709		E
0.748	UX5190	UX-d190-E-C20-H115-L170	0.787	1.516	3.012	4.528	6.693	2.165	0.709		E
0.787	UX6200	UX-d200-F-C25-H120-L175	0.984	1.713	3.012	4.724	6.890	2.165	0.787	UX0009/ M4x0.5x19F	F
0.827	UX6210	UX-d210-F-C25-H120-L175	0.984	1.713	3.012	4.724	6.890	2.165	0.787		F
0.866	UX6220	UX-d220-F-C25-H120-L175	0.984	1.713	3.012	4.724	6.890	2.165	0.787		F
0.906	UX7230	UX-d230-G-C25-H120-L175	0.984	1.890	2.835	4.724	6.890	2.165	0.866	UX0010/ M4x0.5x21G	G
0.945	UX7240	UX-d240-G-C25-H120-L175	0.984	1.890	2.835	4.724	6.890	2.165	0.866		G
0.984	UX7250	UX-d250-G-C25-H120-L175	0.984	1.890	2.835	4.724	6.890	2.165	0.866		G

(1) FL - Folding Length.



(2) RFC - Relief For Cutting.

(3) LTB (Length to bottom) parameter varies between **USPOT** and **UCHAMF** inserts.

(4) The insert series must match the series of the tool-holder.

NOTE Tool-holders and inserts are sold separately.

UX Tool-holder Spare Parts:

-  Hex L-Key - SP0105 0.050" 1 + 1/16 /1 + 9/16
-  Insert Clamping Screw- according to the table above.
-  Pin - UX0003

UBACK PROGRAMMING

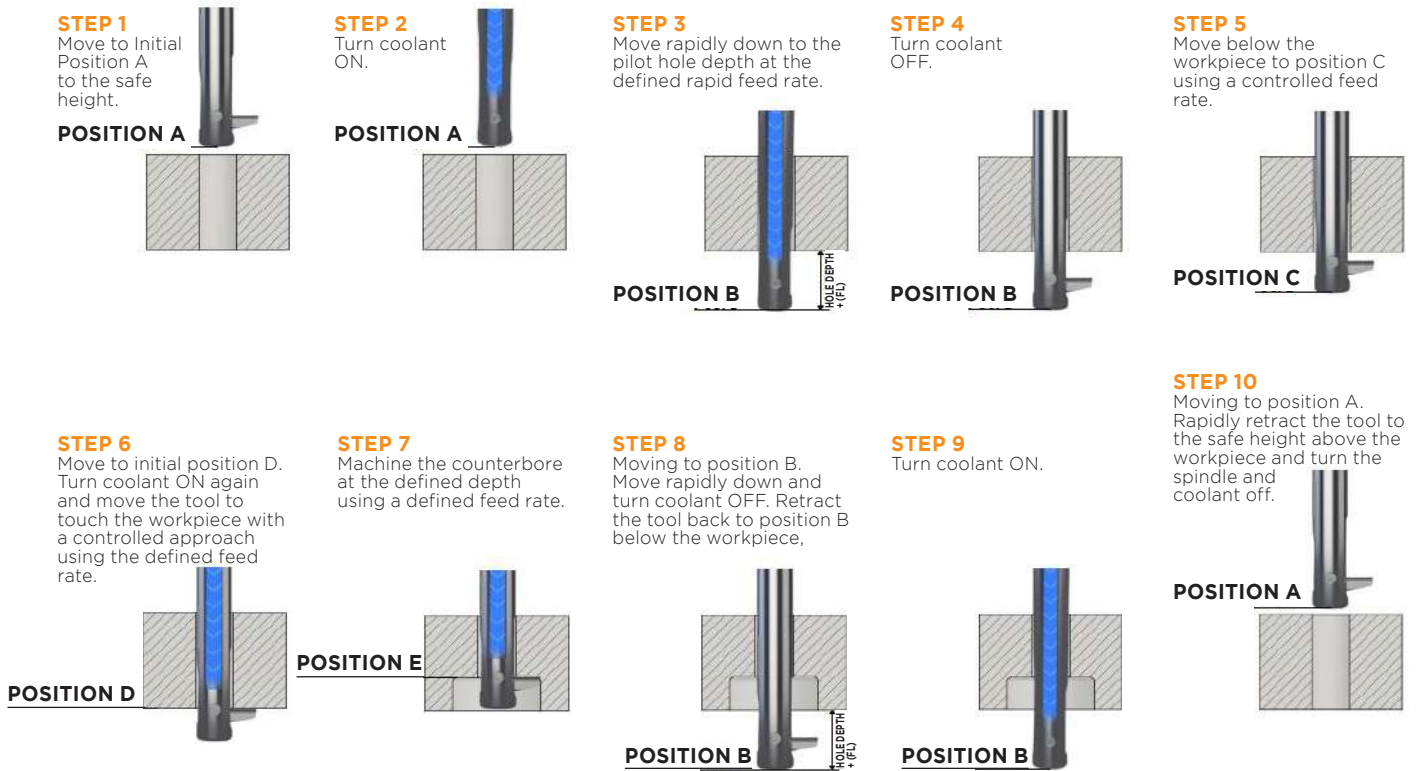

1. The Folding Length (FL) parameter is listed in the tool-holder tables and is the same for both **USPOT** inserts and **UCHAMF** inserts.
2. The illustrated operation sequence above demonstrates working with a **USPOT** insert but remains the same when using a **UCHAMF** insert.

UBACK CHIP-FORMERS

PL
POSITIVE CUTTING LAND
Suitable for all-round purpose and ISO, P, M, K, N, S, as well as composite materials

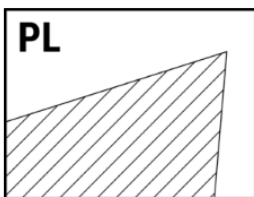

ML
MODERATE CUTTING LAND
Suitable for ISO, P, M, K, S, H. materials

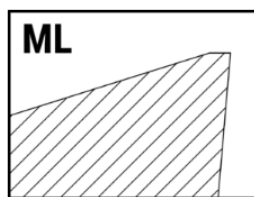

HL
NEGATIVE CUTTING LAND
Suitable for ISO, P, M, K, S, H. materials

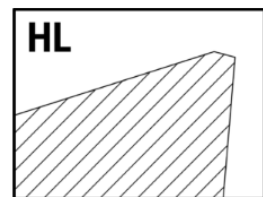

U^BACK

INSERT REPLACEMENT

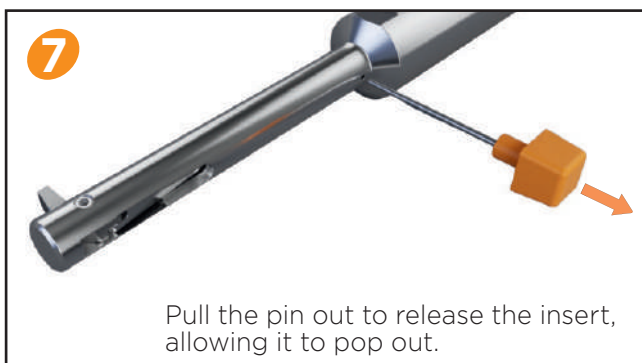
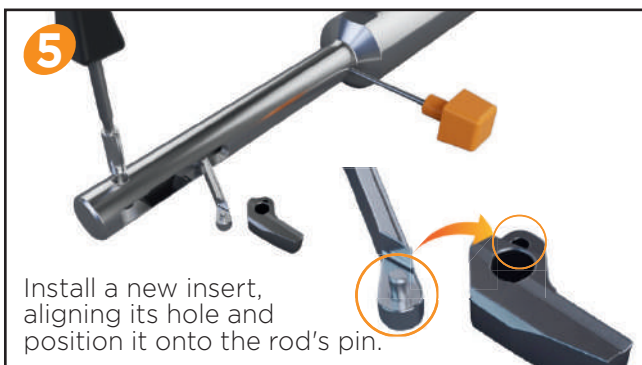
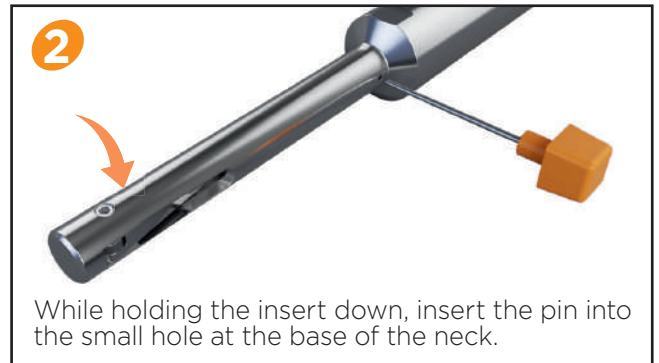

UBACK

COUNTERBORING MACHINING GUIDELINES FOR SPECIFIC CONDITIONS

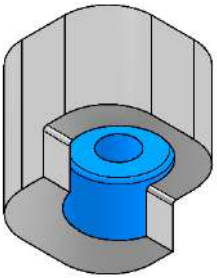

COUNTERBORE ON SHOULDER

- Fully Interrupted Cut.
- **Use external coolant only.**
- Consider reduced stability and adjust cutting parameters by reducing them by 30%.

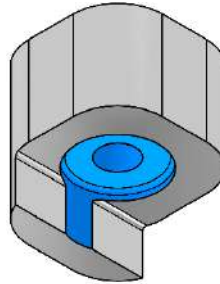

COUNTERBORE ON SHOULDER

- Fully Interrupted Cut.
- **Use external coolant only.**
- Consider reduced stability and adjust cutting parameters by reducing them by 30%.

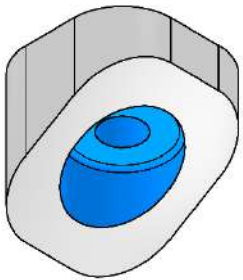

COUNTERBORE ON SLOPED SURFACE

- **Use external coolant only.**

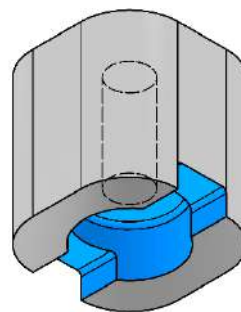

COUNTERBORE ON SLOT

- Fully Interrupted Cut.
- **Use external coolant only.**
- Consider reduced stability and adjust cutting parameters by reducing them by 30%.

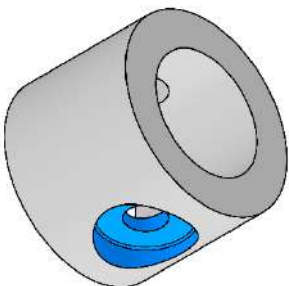

COUNTERBORE ON CYLINDRICAL BORE

- **Use external coolant only.**

UBACK

CONFIGURING UBACK TOOL-HOLDERS FOR DIFFERENT COOLANT SYSTEMS

UBACK tool-holders are compatible with air, emulsion, or MQL coolant systems. When using air as the coolant, close off the back of the tool using the supplied BR05006 - M5 x 6 mm set screw.



COATINGS OR SURFACE TREATMENTS

COATING	KEY FEATURES	APPLICATIONS	INDUSTRIES	MATERIAL EXAMPLES	ISO GROUP					
					P	M	K	N	S	H
TiAlN	Suitable for mid steels, cast iron, stainless steel, titanium alloys, Inconel, tool steel, and hardened steels. Offers excellent thermal stability, oxidation resistance, and wear resistance.	Ideal for high-speed cutting and general-purpose machining. Performs well in both wet and dry conditions.	Aerospace, Automotive, General Engineering	AISI 304, 42CrMo4, GG (Grey Cast Iron), Ti6Al4V	√	√	√	X	√	√
TiAlSiN	Provides exceptional hardness and oxidation resistance, withstanding temperatures above 1,200°C. Suitable for high-strength steels, superalloys, hardened steels (over 45 Rc), and titanium alloys.	Best for high-performance machining in demanding environments. Excels in dry machining at high speeds.	Aerospace, Automotive, Die & Mold	Inconel 718, AISI 4140, Ti6Al4V	√	√	X	X	√	X
AlTiSiN	Offers high hardness, thermal stability, and resistance to wear and oxidation. Suitable for stainless steel, hardened cast, superalloys, and steels over 45 Rc.	Designed for high-speed machining in extreme conditions. Performs exceptionally in dry machining.	Aerospace, Automotive, Precision Engineering	AISI 316, AISI H13, Hastelloy	X	√	X	X	√	√
AlCrN	Provides excellent oxidation resistance (up to 1,100°C), toughness, and abrasion resistance. Suitable for carbon steels, cast iron, stainless steel, and aluminum.	Suitable for general machining in wet and dry environments. Excels in abrasive and high-wear applications.	Automotive, Aerospace, Die and Mold	AISI 304, AISI 1045, GG, AL6061	√	X	√	√	X	X
AlTiN	High hardness, wear resistance, and thermal stability up to 1,100°C. Designed for mid steels, cast iron, high-speed steels, tool steel, and hardened materials.	Ideal for heavy-duty machining and high-speed cutting. Performs well in dry and abrasive conditions.	Aerospace, Automotive, Heavy Engineering	AISI 4340, M2 HSS, GG (Grey Cast Iron)	√	√	√	X	X	X
TiB2	Known for exceptional chemical stability, low friction, and high thermal conductivity. Best for machining non-ferrous materials such as aluminum, copper, brass, and magnesium alloys.	Optimized for high-speed machining of non-ferrous metals. Prevents material adhesion and improves efficiency.	Aerospace, Automotive, Electronics	AL7075, 6061-T6, Copper, Magnesium Alloys (AZ31)	X	X	X	√	√	X
Polishing	Provides a smooth, refined surface finish by removing micro-defects, scratches, or burrs. Enhances aesthetics and surface quality. Reduces friction and BUE.	Suitable for machining aluminium with high speeds and high MRR (Metal Removal Rates).	Aerospace, Automotive.	AL7075, 6061-T6, Copper, Magnesium Alloys (AZ31)	X	X	X	√	X	X



For additional details about our UBACK products, including the complete product range and technical guidelines, please visit our website at: <https://nogamt.com/uback/>

CUTTING RECOMMENDATIONS

(1) To ensure optimal performance and tool-life under varying conditions:

- For moderate tool-holder or workpiece stability, consider reducing feed rates by up to 10%.
- For poor tool-holder or workpiece stability, it's advisable to decrease feed rates by up to 30%.

ISO	MATERIAL		CONDITION	As is AISI/SAE/ASTM	DIN W.-Nr.
P	Non-Alloy Steel and Cast Steel Free Cutting Steel	<0.25%C	Annealed	1020	1.0044
		≥0.25%C	Annealed	1035	1.0501
		<0.55%C	Quenched and tempered	1045	1.1201
		≥0.25%C	Annealed	1055	1.0535
	Low Alloy and Cast Steel (less than 5% of Alloying Elements)		Annealed	G92600	1.5028
		Quenched and Tempered		4130	1.7218
				4142	1.2332
	High-Alloy Steel, Cast Steel and Tool Steel		Annealed	H13	1.2344
			Quenched and Tempered	M33	1.3249
	Stainless Steel, Cast Steel		Ferritic / Martensitic	420	1.4021
		Martensitic			
M	Stainless Steel, Cast Steel		Austenitic, Duplex	304L	1.4306
K	Cast Iron (GG)		Ferritic / Pearlitic	Class 25	0.6015
			Pearlitic / Martensitic	Grade H20	36037
	Nodular Cast Iron (GGG)		Ferritic	60-40-18	0.7043
			Pearlitic	F33500	0.705
	Malleable Cast Iron		Ferritic	A47	0.8135
		Pearlitic	A220 Class	0.8155	
N	Aluminum - Wrought Alloys		Not Hardenable	5005	3.3315
			Hardenable	7075	3.4365
	Aluminum - Cast Alloys	<12%Si	Not Hardenable	518	3.3292
			Hardenable	515	3.3241
	Copper Alloys	>12%Si	High Temperature	390	
		≥ 1% Pb	Free Cutting	C36000	2.0375
			Brass	C22000	2.023
			Electrolytic Copper	C63000	2.0966
Non Metallic		Duroplastics, Fiber Plastics	Bakelite		
		Hard Rubber	Ebonite		
S	High Temperature Alloys	Fe based	Annealed	330	1.4864
			Hardened	S590	1.4977
		Ni or Co based	Annealed	Inconoly 825	2.4858
			Hardened	Inconel 718	2.4668
	Titanium Alloys		Cast	Nimocast K24	2.4674
			Pure	Titanium G.1	3.7024
			Alpha+Beta Alloys, Hardened	Titanium G.5	3.7165
H	Hardened steel		Hardened	HARDOX 500	
			Hardened	HARDOX EXTREME	
	Chilled Cast Iron		Cast	A532 IIIA 25% Cr	0.965
	Cast Iron		Hardened	A532 IID 20% CrMo	0.9645

CUTTING RECOMMENDATIONS

The table shown on page 38-39 presents cutting recommendations, outlining initial feed rates and cutting speed for materials group based on ISO 513 and VDI 3323 standards.

Additionally, the operator must ensure the utilization of appropriate coolant media directed to the cutting tip of the blade and right-hand machining (clockwise).

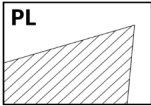
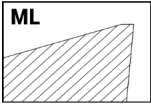
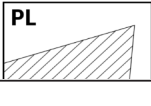
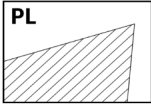
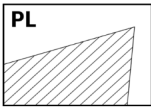
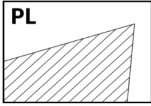
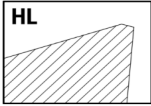
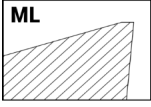
ISO	Vc cutting speed m/min. sfm	Series B fz ⁽¹⁾ cutting speed mm/t. ipt	Series C fz ⁽¹⁾ cutting speed mm/t. ipt	Series D fz ⁽¹⁾ cutting speed mm/t. ipt	Series E fz ⁽¹⁾ cutting speed mm/t. ipt	Series F fz ⁽¹⁾ cutting speed mm/t. ipt	Series G fz ⁽¹⁾ cutting speed mm/t. ipt	RECOMMENDED CHIP-FORMER	COOLANT
P	60 - 120 / 200 - 390	0.03 / 0.0012"	0.04 / 0.0016"	0.05 / 0.0020"	0.07 / 0.0028"	0.08 / 0.0031"	0.09 / 0.0035"		AIR / WET
	50 - 120 / 165 - 390	0.03 / 0.0012"	0.04 / 0.0016"	0.05 / 0.0020"	0.07 / 0.0028"	0.08 / 0.0031"	0.09 / 0.0035"		
	50 - 100 / 165 - 330								
	40 - 90 / 150 - 295	0.02 / 0.0008"	0.03 / 0.0012"	0.04 / 0.0016"	0.05 / 0.0020"	0.06 / 0.0024"	0.08 / 0.0031"		
M	50 - 100 / 165 - 330	0.03 / 0.0012"	0.04 / 0.0016"	0.05 / 0.0020"	0.07 / 0.0028"	0.08 / 0.0031"	0.09 / 0.0035"		WET
K	60 - 120 / 200 - 395	0.03 / 0.0012"	0.04 / 0.0016"	0.05 / 0.0020"	0.07 / 0.0028"	0.08 / 0.0031"	0.09 / 0.0035"		AIR / WET
	50 - 100 / 165 - 330	0.02 / 0.0008"	0.03 / 0.0012"	0.04 / 0.0016"	0.05 / 0.0020"	0.06 / 0.0024"	0.08 / 0.0031"		
N	100 - 160 / 330 - 525	0.05 / 0.0020"	0.06 / 0.0024"	0.08 / 0.0031"	0.10 / 0.0039"	0.12 / 0.0047"	0.14 / 0.0055"		WET
	90 - 130 / 295 - 425								
	180 - 305 / 600 - 1000								
S	40 - 80 / 130 - 260	0.02 / 0.0008"	0.03 / 0.0012"	0.04 / 0.0016"	0.05 / 0.0020"	0.06 / 0.0024"	0.08 / 0.0031"		WET
	25 - 40 / 80 - 130								
	30 - 60 / 100 - 180								
H	30 - 50 / 100 - 165	0.02 / 0.0008"	0.02 / 0.0008"	0.03 / 0.0012"	0.04 / 0.0016"	0.05 / 0.0020"	0.06 / 0.0024"		AIR
	30 - 40 / 100 - 130								
	45 - 50 / 145 - 165	0.02 / 0.0008"	0.02 / 0.0008"	0.03 / 0.0012"	0.04 / 0.0016"	0.05 / 0.0020"	0.06 / 0.0024"		
	30 - 50 / 100 - 165	0.02 / 0.0008"	0.02 / 0.0008"	0.03 / 0.0012"	0.04 / 0.0016"	0.05 / 0.0020"	0.06 / 0.0024"		

U**LTIMATE** U**BURR!** TOOLS

A MARK OF EXCELLENCE

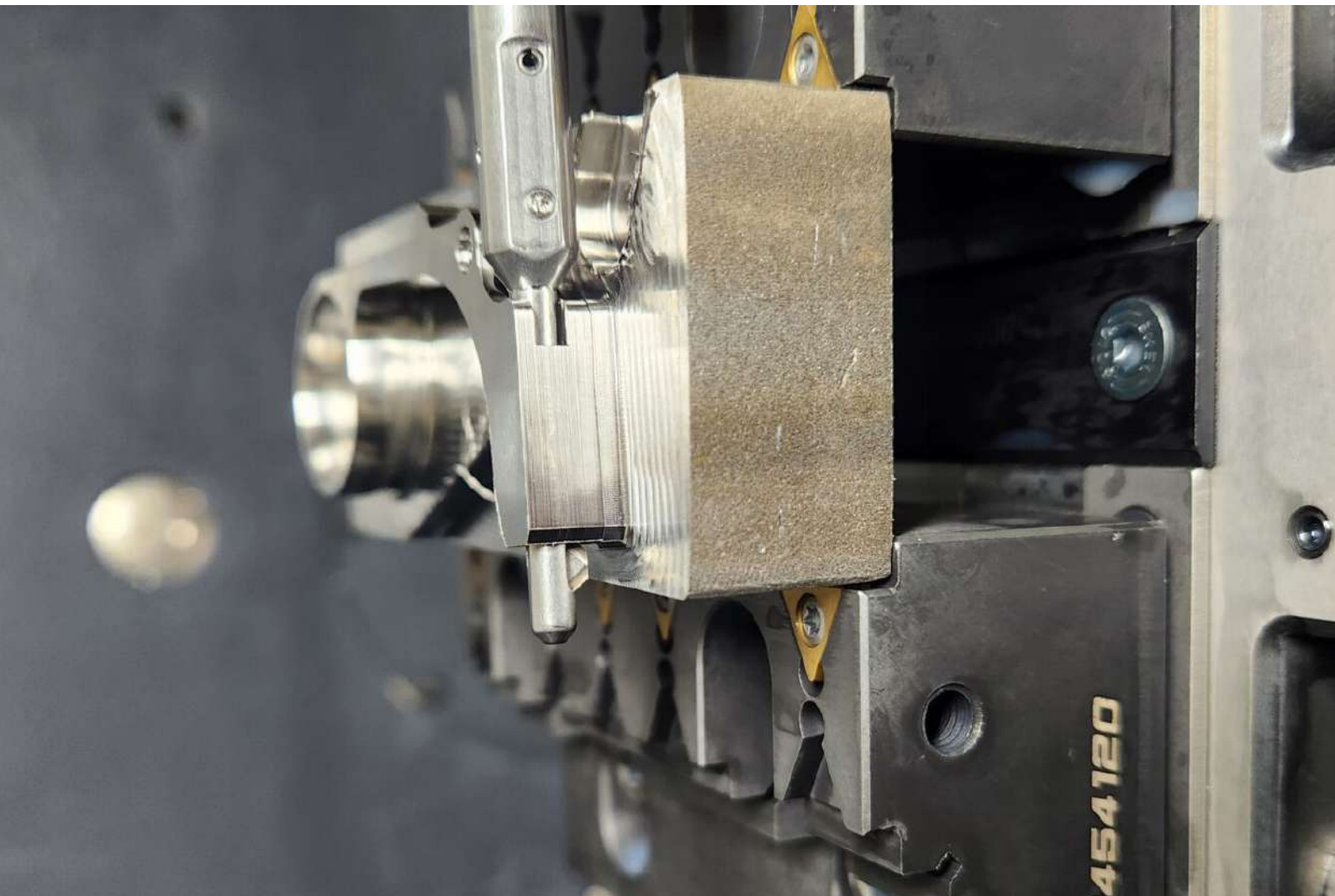

At NOGA MT, our vision is clear: to deliver unparalleled excellence through top-quality products engineered by skilled professionals and crafted from the finest materials our world has to offer. Join us as we redefine deburring with **UBURR**.

ULTIMATE UBURR! TOOLS

UBURR SETS NEW STANDARDS

Enter NOGA MT **UBURR** – a family of deburring tools designed to streamline the automatic deburring process, comprising two essential components.

- 1** Precision cutting blade with unique geometry with different chip-formers and sizes.
- 2** MT DURASHIELD state-of-the-art tool-holder as never seen before in the industry for the metal cutting tools.



UBURR sets a new standard in deburring efficiency and excellence.

In the realm of machining and manufacturing, deburring tools play a crucial role, ensuring that drilled holes are clean, smooth, and free from any unwanted burrs that could affect performance or aesthetics.

UBURR

HOW DOES THE UBURR WORK?

- 1** Upon insertion, the replaceable cutting blade is initially held in the extended position, effectively eliminating the burr on the front side of the hole.
- 2** As the cutting tool encounters increased feed pressure, surpassing the preset spring tension, the blade automatically retracts while passing through the pilot-hole. The unique geometry of the blade ensures no scratches occurs on the inner surface of the pilot-hole threaded or drilled.
- 3** Upon exiting the pilot-hole, spring tension once again triggers the blade to extend, effectively removing the burr on the back side of the hole during the return stroke.

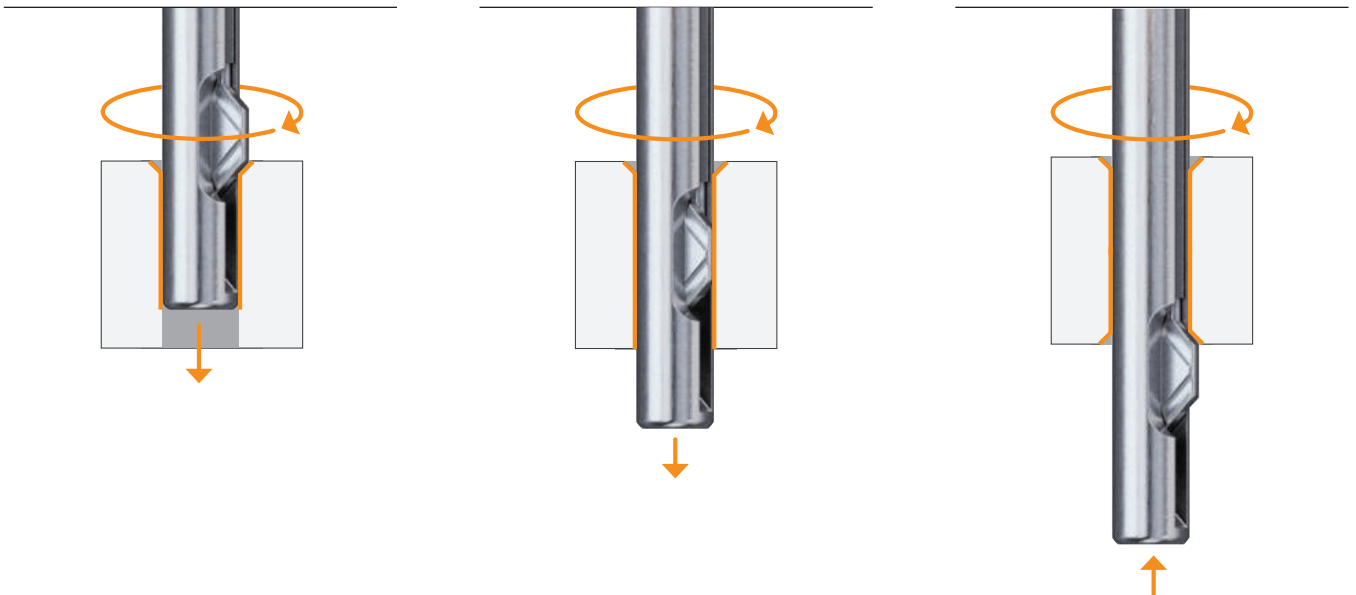

UBURR MAIN BENEFITS

OPERATIONAL EXCELLENCE

AUTOMATED EFFICIENCY:

- Achieve seamless production with single-pass automatic deburring of both front and rear hole edges, eliminating the need for manual intervention.

PRECISION PERFORMANCE:

- Consistently deliver high-quality deburring results at any production volume.

PREMIUM CONSTRUCTION:

- Manufactured from Precipitation Hardened AISI 17-4 PH for outstanding durability and dependable performance.

UBURR

MAIN BENEFITS

VERSATILE APPLICATION

UNIVERSAL COMPATIBILITY:

- Operates effectively with both CNC machines and electric hand drills.

ADAPTIVE DESIGN:

- A single holder supports multiple pilot diameters, reducing the need for extensive tool inventory.

COMPREHENSIVE MATERIAL AND GEOMETRICAL SUPPORT:

- The blades are available in HSS or Solid Carbide, with TiAlN PVD coated or uncoated blades and 3 types of chip formers, for efficient processing of various materials.



SMART DESIGN FEATURES

PLUG-AND-PLAY CONVENIENCE:

- No blade adjustments required, saving time and ensuring consistent, repeatable results.

PROTECTIVE GEOMETRY:

- Specialized blade design prevents scratches on drilled or threaded surfaces.

SIMPLIFIED MAINTENANCE:

- Quick and intuitive blade replacement minimizes downtime.

EFFICIENT INVENTORY MANAGEMENT:

- Only three blade types needed for all hole diameters.

CUSTOMIZABLE SOLUTIONS:

- Tailored configurations available to meet specific production needs.

UBURR

BLADE FEATURES:

Our high-precision blades, made of High-Speed Steel (HSS) and Solid-Carbide, offer toughness and durability, enabling them to withstand high impact loads and shock during machining processes. This enhances tool reliability and minimizes the risk of tool breakage or chipping, while also exhibiting excellent resistance to wear and abrasion. They can withstand prolonged use without significant deterioration in cutting performance, extending tool life and reducing the frequency of tool replacements.

The blade's unique geometry is engineered to prevent damage to the inner surfaces of the hole while entering it, maintaining the integrity of the workpiece with every pass, and featuring a unique spherical surface.

UBURR BLADE CUTTING-EDGE GEOMETRY

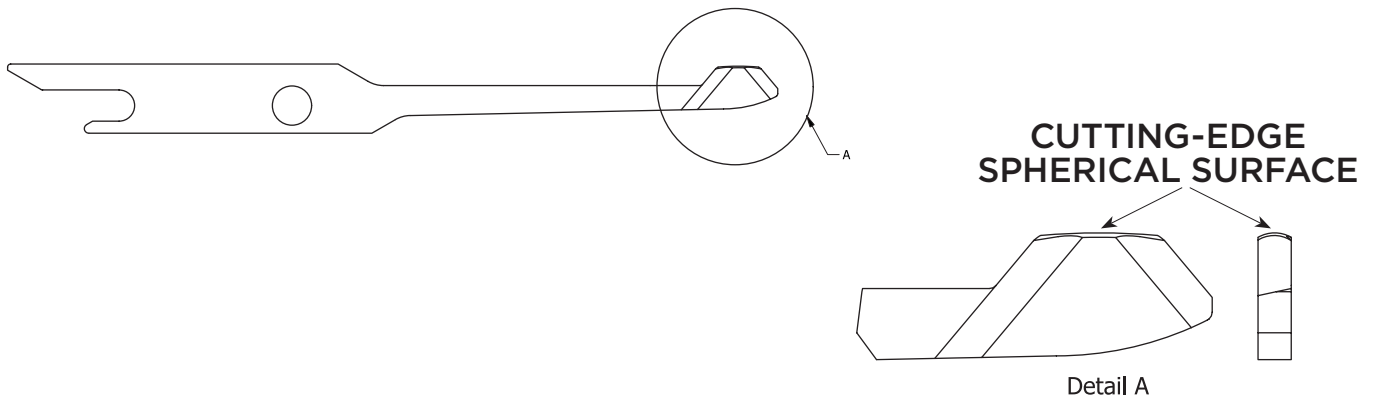

UBURR blades are available in Type 2.5, 3 and Type 5 sizes, with each type offering PL, ML or HL chip-formers, coated with TiAlN or uncoated.

AVAILABLE CHIP-FORMERS

PL
POSITIVE CUTTING LAND
Suitable for all-round purpose and ISO, P, M, K, N, S, as well as composite materials

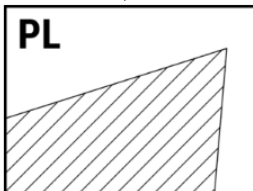

ML
MODERATE CUTTING LAND
Suitable for ISO, P, M, K, S, H. materials

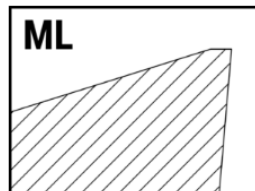

HL
NEGATIVE CUTTING LAND
Suitable for ISO, P, M, K, S, H. materials

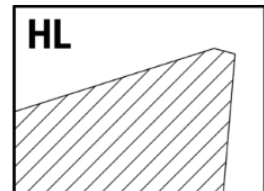

UBURR

BLADE FEATURES:

Each blade (except size 2.5) comes with an rMQR rectangular engraved laser code for technical information, including machining guidelines and cutting parameters.



Download the QRBOT app to scan the Rectangular Micro QR Code (rMQR) and access the UBURR machining guidelines.



UBURR BLADES CODING SYSTEM SPECIFICATIONS AND IDENTIFICATION:

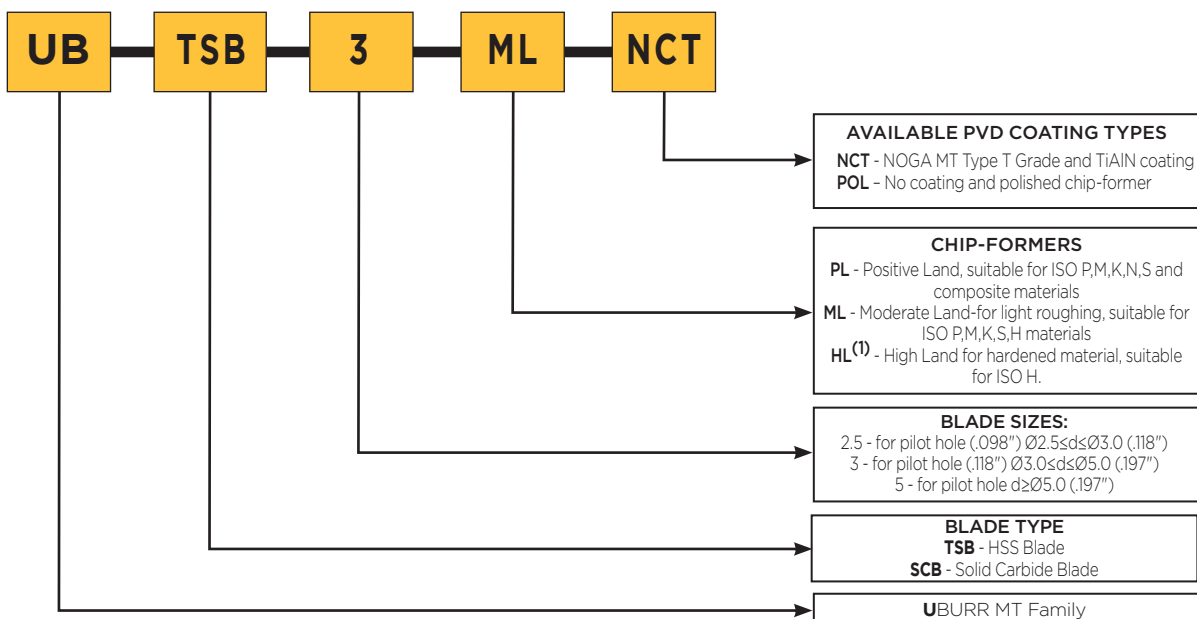

⁽¹⁾ Available only as special

UBURR

BLADE REMOVAL

- 1 Remove the blade: Unlock the screw using an Allen key with a counterclockwise turn of the locking screw.
- 2 Push the blade by hexagon key through.
- 3 Pull up the blade from the holder.

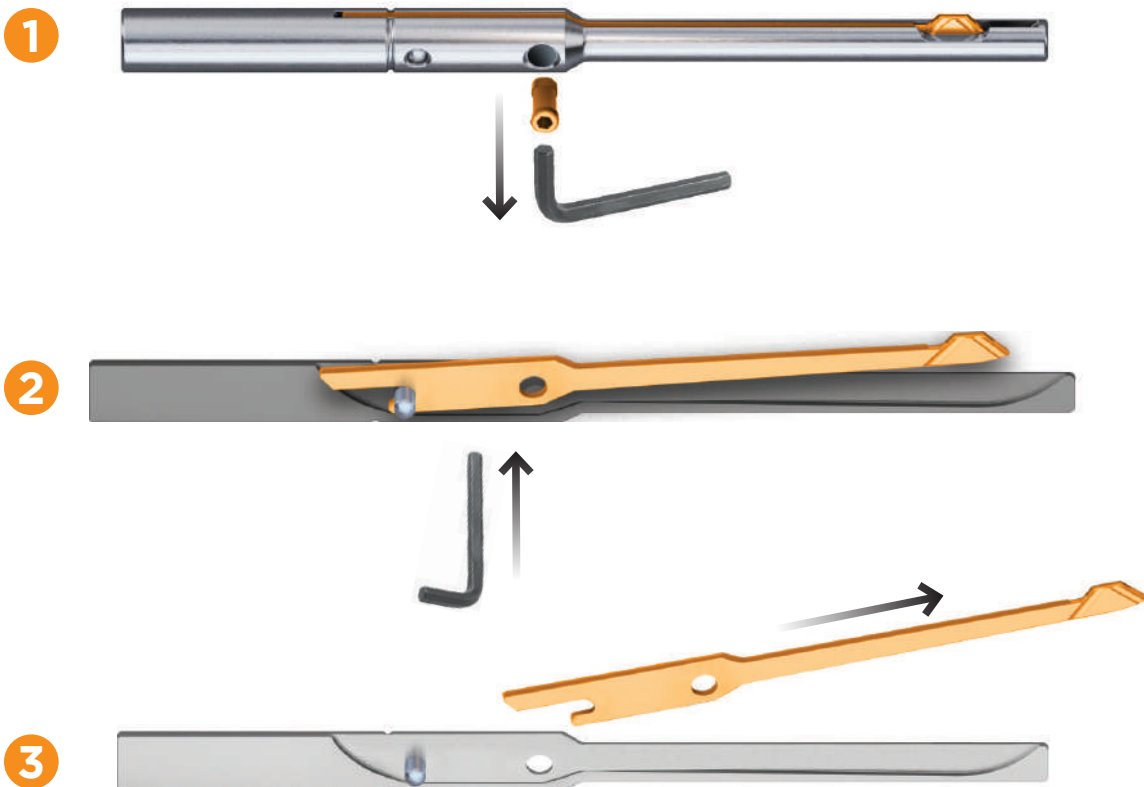

UBURR

BLADE INSERTION

- 1 Insert the blade into the holder slot.
- 2 Push the blade into the tool pocket.
- 3 Lock the screw clockwise.

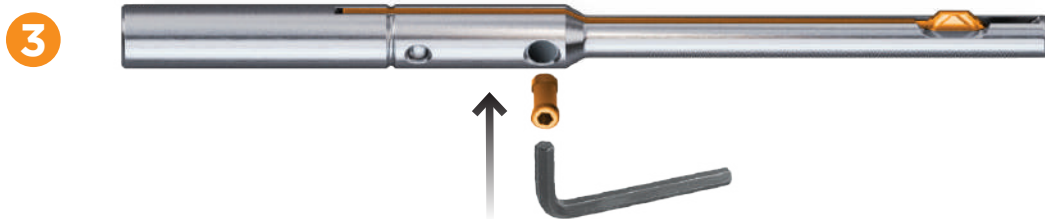
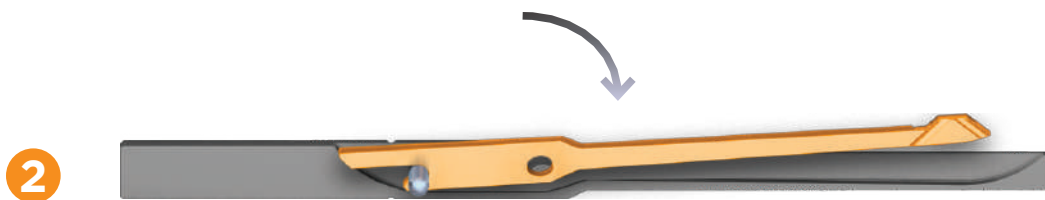
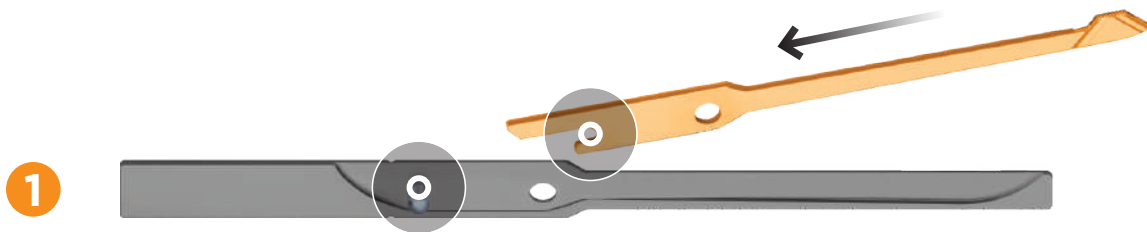

UBURR

UBURR BLADES SPECIFICATIONS TABLE

SIZE 2.5 ⁽¹⁾ BLADE for pilot hole $\varnothing 2.5$ (0.098") $\leq d < \varnothing 3.0$ (0.118")		
SKU BLADE	DESIGNATION	DESCRIPTION
UB2020 ⁽¹⁾	UB-TSB-2.5-PL	HSS Blade size 2.5 without coating and type P chip-former
SIZE 3 BLADE for pilot hole $\varnothing 3.0$ (0.118") $\leq d < \varnothing 5.0$ (0.197")		
SKU BLADE	DESIGNATION	DESCRIPTION
UB2030	UB-TSB-3-PL	HSS blade size 3 without coating and type P chip-former
UB2032	UB-TSB-3-PL-NCT	HSS blade size 3 with TiAlN coating and type P chip-former
UB2034	UB-TSB-3-ML-NCT	HSS blade size 3 with TiAlN coating and type M chip-former
UB2036	UB-SCB-3-PL-NCT	Carbide blade size 3 with TiAlN coating and type P chip-former
UB2038	UB-SCB-3-ML-NCT	Carbide blade size 3 with TiAlN coating and type M chip-former
SIZE 5 BLADE for pilot hole $d \geq \varnothing 5.0$ (0.197")		
SKU BLADE	DESIGNATION	DESCRIPTION
UB2060	UB-TSB-5-PL	HSS blade size 5 without coating and type P chip-former
UB2062	UB-TSB-5-PL-NCT	HSS blade size 5 with TiAlN coating and type P chip-former
UB2063	UB-TSB-5-ML-NCT	HSS blade size 5 with TiAlN coating and type M chip-former
UB2067	UB-SCB-5-PL-NCT	Carbide blade size 5 with TiAlN coating and type P chip-former
UB2069	UB-SCB-5-ML-NCT	Carbide blade size 5 with TiAlN coating and type M chip-former

⁽¹⁾ The UB2020 blade is designed only for back deburring

UBURR TOOL-HOLDERS CODING SYSTEM SPECIFICATIONS AND IDENTIFICATION:

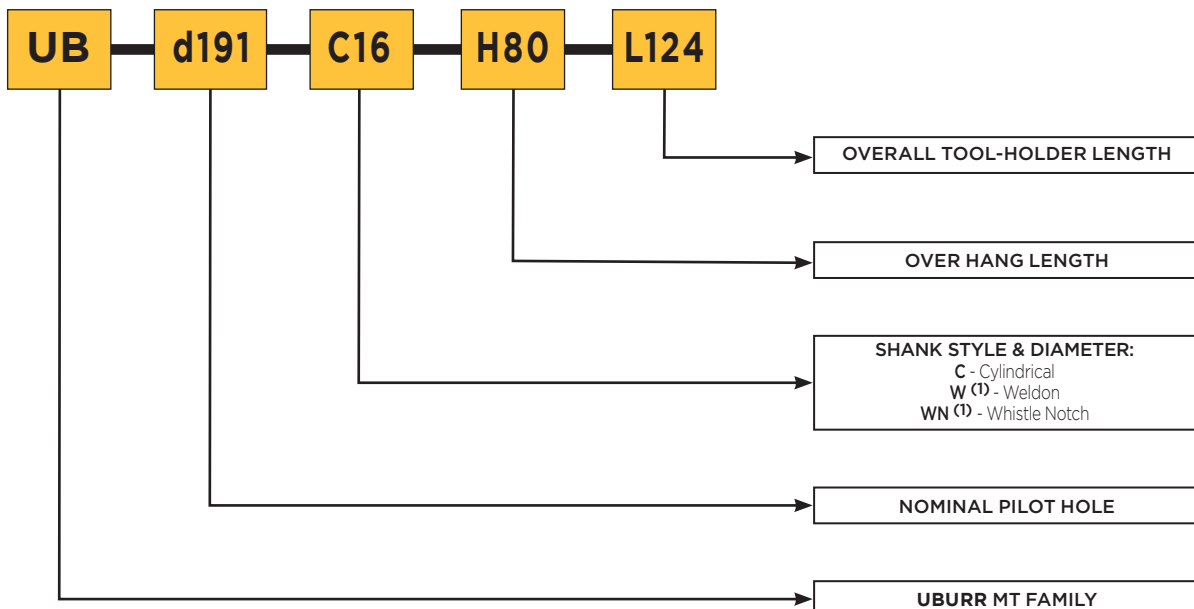

⁽¹⁾ Available only as special

UBURR

TOOL-HOLDER FEATURES

UBURR tool-holders bearing the **DURASHIELD** mark deliver premium performance in demanding manufacturing environments. Each tool represents the pinnacle of precision engineering and reliability, manufactured from Precipitation Hardened AISI 17-4 PH for outstanding durability and performance.



UBURR TOOL-HOLDER RANGE

The **UBURR** standard tool series covers a wide range of pilot holes from Ø2.5 to Ø25mm (0.098 to 0.984”) with 0.5mm (.0197”) increments.

SUPERIOR STRENGTH: Engineered to handle heavy loads and demanding machining operations with consistent performance.

MAXIMUM TOUGHNESS: Maintains reliable operation under the most challenging industrial conditions.

ENHANCED WEAR RESISTANCE: Extended tool life significantly reduces operational costs and maintenance requirements.

PRECISION MACHINABILITY: Designed for optimal accuracy and consistent performance.

THERMAL STABILITY: Maintains structural integrity and precision even at elevated temperatures.

ADVANCED CORROSION PROTECTION: Features a specialized passivation process that provides superior protection without additional coatings.

ENVIRONMENTAL INNOVATION: The eco-friendly manufacturing process eliminates the need for additional protective layers while delivering superior performance in all working conditions.

UBURR

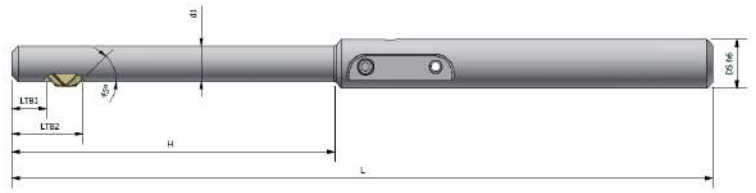
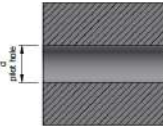

UBURR TOOL-HOLDERS (mm)

Ød min. PILOT HOLE RANGE	SKU TOOL- HOLDER	DESCRIPTION TOOL-HOLDER	+	SKU BLADE	=	DESCRIPTION SET	SKU SET	ØDS h6	LTB1 ⁽²⁾	LTB2 ⁽²⁾	H	L
2.50-3.00	UB1025	UB-d025-C08-H29-L69	+	UB2020 ⁽¹⁾	=	UBS-d025-C08-H29-L69	UB2500	8	N/A	7	29	69
3.00-3.50	UB1030	UB-d030-C08-H29-L85	+	UB2030	=	UBS-d030-C08-H29-L85	UB3000	8	4	10	29	85
3.50-4.00	UB1035	UB-d035-C08-H29-L85	+	UB2030	=	UBS-d035-C08-H29-L85	UB3001	8	4	10	29	85
4.00-4.50	UB1040	UB-d040-C08-H29-L85	+	UB2030	=	UBS-d040-C08-H29-L85	UB3002	8	4	10	29	85
4.50-5.00	UB1045	UB-d045-C08-H29-L85	+	UB2030	=	UBS-d045-C08-H29-L85	UB3003	8	4	10	29	85
5.00-5.50	UB1050	UB-d050-C08-H53-L115	+	UB2060	=	UBS-d050-C08-H53-L115	UB3004	8	4	12	53	115
5.50-6.00	UB1055	UB-d055-C08-H53-L115	+	UB2060	=	UBS-d055-C08-H53-L115	UB3005	8	4	12	53	115
6.00-6.50	UB1060	UB-d060-C08-H53-L115	+	UB2060	=	UBS-d060-C08-H53-L115	UB3006	8	4	12	53	115
6.50-7.00	UB1065	UB-d065-C08-H53-L115	+	UB2060	=	UBS-d065-C08-H53-L115	UB3007	8	4	12	53	115
7.00-7.50	UB1070	UB-d070-C08-H53-L115	+	UB2060	=	UBS-d070-C08-H53-L115	UB3008	8	4	12	53	115
7.50-8.00	UB1075	UB-d075-C08-H53-L115	+	UB2060	=	UBS-d075-C08-H53-L115	UB3009	8	4	12	53	115
8.00-8.50	UB1080	UB-d080-C10-H53-L115	+	UB2060	=	UBS-d080-C10-H53-L115	UB3010	10	4	12	53	115
8.50-9.00	UB1085	UB-d085-C10-H53-L115	+	UB2060	=	UBS-d085-C10-H53-L115	UB3011	10	4	12	53	115
9.00-9.50	UB1090	UB-d090-C10-H53-L115	+	UB2060	=	UBS-d090-C10-H53-L115	UB3012	10	4	12	53	115
9.50-10.00	UB1095	UB-d095-C10-H53-L115	+	UB2060	=	UBS-d095-C10-H53-L115	UB3013	10	4	12	53	115
10.00-10.50	UB1100	UB-d100-C10-H80-L125	+	UB2060	=	UBS-d100-C10-H80-L125	UB3014	10	4	12	80	125
10.50-11.00	UB1105	UB-d105-C10-H80-L125	+	UB2060	=	UBS-d105-C10-H80-L125	UB3015	10	4	12	80	125
11.00-11.50	UB1110	UB-d110-C10-H80-L125	+	UB2060	=	UBS-d110-C10-H80-L125	UB3016	10	4	12	80	125
11.50-12.00	UB1115	UB-d115-C12-H80-L125	+	UB2060	=	UBS-d115-C12-H80-L125	UB3017	12	4	12	80	125
12.00-12.50	UB1120	UB-d120-C12-H80-L125	+	UB2060	=	UBS-d120-C12-H80-L125	UB3018	12	4	12	80	125
12.50-13.00	UB1125	UB-d125-C12-H80-L125	+	UB2060	=	UBS-d125-C12-H80-L125	UB3019	12	4	12	80	125
13.00-13.50	UB1130	UB-d130-C12-H80-L125	+	UB2060	=	UBS-d130-C12-H80-L125	UB3020	12	4	12	80	125
13.50-14.00	UB1135	UB-d135-C12-H80-L125	+	UB2060	=	UBS-d135-C12-H80-L125	UB3021	12	4	12	80	125
14.00-14.50	UB1140	UB-d140-C12-H80-L125	+	UB2060	=	UBS-d140-C12-H80-L125	UB3022	12	4	12	80	125
14.50-15.00	UB1145	UB-d145-C12-H80-L125	+	UB2060	=	UBS-d145-C12-H80-L125	UB3023	12	4	12	80	125
15.00-15.50	UB1150	UB-d150-C12-H80-L125	+	UB2060	=	UBS-d150-C12-H80-L125	UB3024	12	4	12	80	125
15.50-16.00	UB1155	UB-d155-C12-H80-L125	+	UB2060	=	UBS-d155-C12-H80-L125	UB3025	12	4	12	80	125
16.00-16.50	UB1160	UB-d160-C16-H80-L125	+	UB2060	=	UBS-d160-C16-H80-L125	UB3026	16	4	12	80	125
16.50-17.00	UB1165	UB-d165-C16-H80-L125	+	UB2060	=	UBS-d165-C16-H80-L125	UB3027	16	4	12	80	125
17.00-17.50	UB1170	UB-d170-C16-H80-L125	+	UB2060	=	UBS-d170-C16-H80-L125	UB3028	16	4	12	80	125
17.50-18.00	UB1175	UB-d175-C16-H80-L125	+	UB2060	=	UBS-d175-C16-H80-L125	UB3029	16	4	12	80	125
18.00-18.50	UB1180	UB-d180-C16-H80-L125	+	UB2060	=	UBS-d180-C16-H80-L125	UB3030	16	4	12	80	125
18.50-19.00	UB1185	UB-d185-C16-H80-L125	+	UB2060	=	UBS-d185-C16-H80-L125	UB3031	16	4	12	80	125
19.00-19.50	UB1190	UB-d190-C16-H80-L125	+	UB2060	=	UBS-d190-C16-H80-L125	UB3032	16	4	12	80	125
19.50-20.00	UB1195	UB-d195-C20-H80-L125	+	UB2060	=	UBS-d195-C20-H80-L125	UB3033	20	4	12	80	125
20.00-20.50	UB1200	UB-d200-C20-H80-L125	+	UB2060	=	UBS-d200-C20-H80-L125	UB3034	20	4	12	80	125
20.50-21.00	UB1205	UB-d205-C20-H80-L125	+	UB2060	=	UBS-d205-C20-H80-L125	UB3035	20	4	12	80	125
21.00-21.50	UB1210	UB-d210-C20-H80-L125	+	UB2060	=	UBS-d210-C20-H80-L125	UB3036	20	4	12	80	125

UBURR

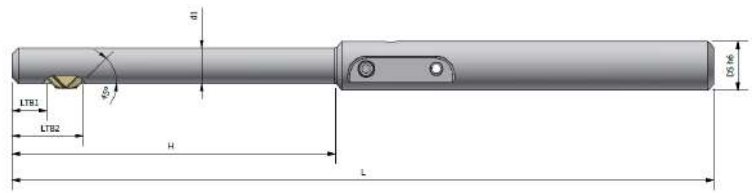
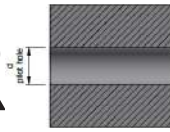



UBURR TOOL-HOLDERS (mm)

Ød min. PILOT HOLE RANGE	SKU TOOL- HOLDER	DESCRIPTION TOOL-HOLDER	+	SKU BLADE	=	DESCRIPTION SET	SKU SET	ØDS h6	LTB1 ⁽²⁾	LTB2 ⁽²⁾	H	L
21.50-22.00	UB1215	UB-d215-C20-H80-L125	+	UB2060	=	UBS-d215-C20-H80-L125	UB3037	20	4	12	80	125
22.00-22.50	UB1220	UB-d220-C20-H80-L125	+	UB2060	=	UBS-d220-C20-H80-L125	UB3038	20	4	12	80	125
22.50-23.00	UB1225	UB-d225-C20-H80-L125	+	UB2060	=	UBS-d225-C20-H80-L125	UB3039	20	4	12	80	125
23.00-23.50	UB1230	UB-d230-C20-H80-L125	+	UB2060	=	UBS-d230-C20-H80-L125	UB3040	20	4	12	80	125
23.50-24.00	UB1235	UB-d235-C20-H80-L125	+	UB2060	=	UBS-d235-C20-H80-L125	UB3041	20	4	12	80	125
24.00-24.50	UB1240	UB-d240-C20-H80-L125	+	UB2060	=	UBS-d240-C20-H80-L125	UB3042	20	4	12	80	125
24.50-25.00	UB1245	UB-d245-C20-H80-L125	+	UB2060	=	UBS-d245-C20-H80-L125	UB3043	20	4	12	80	125
25.00-25.50	UB1250	UB-d250-C20-H80-L125	+	UB2060	=	UBS-d250-C20-H80-L125	UB3044	20	4	12	80	125

(1) The **UB2020** blade is designed only for back deburring.

(2) **LTB** (Length to Blade)

UX Tool-holder Spare Parts:

-  Hex L-Key - SP0105 0.050" 1 + 1/16 /1 + 9/16
-  Blade Clamping Screw - UB0021 M2.5 X 0.35

UBURR

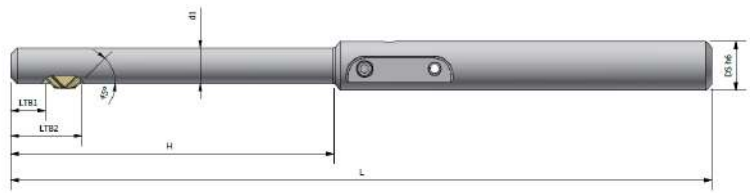
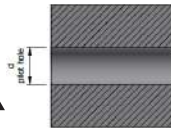

UBURR TOOL-HOLDERS (Inch)

Ød min. PILOT HOLE RANGE	SKU TOOL- HOLDER	DESCRIPTION TOOL-HOLDER	+	SKU BLADE	=	DESCRIPTION SET	SKU SET	ØDS h6	LTB1 ⁽²⁾	LTB2 ⁽²⁾	H	L
0.098-0.118	UB1025	UB-d025-C08-H29-L69	+	UB2020 ⁽¹⁾	=	UBS-d025-C08-H29-L69	UB2500	0.315	N/A	0.276	1.142	2.717
0.118-0.138	UB1030	UB-d030-C08-H29-L85	+	UB2030	=	UBS-d030-C08-H29-L85	UB3000	0.315	0.157	0.394	1.142	3.35
0.138-0.157	UB1035	UB-d035-C08-H29-L85	+	UB2030	=	UBS-d035-C08-H29-L85	UB3001	0.315	0.157	0.394	1.142	3.35
0.157-0.177	UB1040	UB-d040-C08-H29-L85	+	UB2030	=	UBS-d040-C08-H29-L85	UB3002	0.315	0.157	0.394	1.142	3.35
0.177-0.197	UB1045	UB-d045-C08-H29-L85	+	UB2030	=	UBS-d045-C08-H29-L85	UB3003	0.315	0.157	0.394	1.142	3.35
0.197-0.217	UB1050	UB-d050-C08-H53-L85	+	UB2060	=	UBS-d050-C08-H29-L85	UB3004	0.315	0.157	0.472	2.087	4.53
0.217-0.236	UB1055	UB-d055-C08-H53-L115	+	UB2060	=	UBS-d055-C08-H53-L115	UB3005	0.315	0.157	0.472	2.087	4.53
0.236-0.256	UB1060	UB-d060-C08-H53-L115	+	UB2060	=	UBS-d060-C08-H53-L115	UB3006	0.315	0.157	0.472	2.087	4.53
0.256-0.276	UB1065	UB-d065-C08-H53-L115	+	UB2060	=	UBS-d065-C08-H53-L115	UB3007	0.315	0.157	0.472	2.087	4.53
0.276-0.295	UB1070	UB-d070-C08-H53-L115	+	UB2060	=	UBS-d070-C08-H53-L115	UB3008	0.315	0.157	0.472	2.087	4.53
0.295-0.315	UB1075	UB-d075-C08-H53-L115	+	UB2060	=	UBS-d075-C08-H53-L115	UB3009	0.315	0.157	0.472	2.087	4.53
0.315-0.335	UB1080	UB-d080-C08-H53-L115	+	UB2060	=	UBS-d080-C08-H53-L115	UB3010	0.394	0.157	0.472	2.087	4.53
0.335-0.354	UB1085	UB-d085-C08-H53-L115	+	UB2060	=	UBS-d085-C08-H53-L115	UB3011	0.394	0.157	0.472	2.087	4.53
0.354-0.374	UB1090	UB-d090-C08-H53-L115	+	UB2060	=	UBS-d090-C08-H53-L115	UB3012	0.394	0.157	0.472	2.087	4.53
0.374-0.394	UB1095	UB-d095-C08-H53-L115	+	UB2060	=	UBS-d095-C08-H53-L115	UB3013	0.394	0.157	0.472	2.087	4.53
0.394-0.413	UB1100	UB-d100-C10-H80-L125	+	UB2060	=	UBS-d100-C10-H80-L125	UB3014	0.394	0.157	0.472	3.15	4.92
0.413-0.433	UB1105	UB-d105-C10-H80-L125	+	UB2060	=	UBS-d105-C10-H80-L125	UB3015	0.394	0.157	0.472	3.15	4.92
0.433-0.453	UB1110	UB-d110-C10-H80-L125	+	UB2060	=	UBS-d110-C10-H80-L125	UB3016	0.394	0.157	0.472	3.15	4.92
0.453-0.472	UB1115	UB-d115-C12-H80-L125	+	UB2060	=	UBS-d115-C12-H80-L125	UB3017	0.472	0.157	0.472	3.15	4.92
0.472-0.492	UB1120	UB-d120-C12-H80-L125	+	UB2060	=	UBS-d120-C12-H80-L125	UB3018	0.472	0.157	0.472	3.15	4.92
0.492-0.512	UB1125	UB-d125-C12-H80-L125	+	UB2060	=	UBS-d125-C12-H80-L125	UB3019	0.472	0.157	0.472	3.15	4.92
0.512-0.531	UB1130	UB-d130-C12-H80-L125	+	UB2060	=	UBS-d130-C12-H80-L125	UB3020	0.472	0.157	0.472	3.15	4.92
0.531-0.551	UB1135	UB-d135-C12-H80-L125	+	UB2060	=	UBS-d135-C12-H80-L125	UB3021	0.472	0.157	0.472	3.15	4.92
0.551-0.571	UB1140	UB-d140-C12-H80-L125	+	UB2060	=	UBS-d140-C12-H80-L125	UB3022	0.472	0.157	0.472	3.15	4.92
0.571-0.591	UB1145	UB-d145-C12-H80-L125	+	UB2060	=	UBS-d145-C12-H80-L125	UB3023	0.472	0.157	0.472	3.15	4.92
0.591-0.610	UB1150	UB-d150-C12-H80-L125	+	UB2060	=	UBS-d150-C12-H80-L125	UB3024	0.472	0.157	0.472	3.15	4.92
0.610-0.630	UB1155	UB-d155-C12-H80-L125	+	UB2060	=	UBS-d155-C12-H80-L125	UB3025	0.472	0.157	0.472	3.15	4.92
0.630-0.650	UB1160	UB-d160-C16-H80-L125	+	UB2060	=	UBS-d160-C16-H80-L125	UB3026	0.630	0.157	0.472	3.15	4.92
0.650-0.669	UB1165	UB-d165-C16-H80-L125	+	UB2060	=	UBS-d165-C16-H80-L125	UB3027	0.630	0.157	0.472	3.15	4.92
0.669-0.689	UB1170	UB-d170-C16-H80-L125	+	UB2060	=	UBS-d170-C16-H80-L125	UB3028	0.630	0.157	0.472	3.15	4.92
0.689-0.709	UB1175	UB-d175-C16-H80-L125	+	UB2060	=	UBS-d175-C16-H80-L125	UB3029	0.630	0.157	0.472	3.15	4.92
0.709-0.728	UB1180	UB-d180-C16-H80-L125	+	UB2060	=	UBS-d180-C16-H80-L125	UB3030	0.630	0.157	0.472	3.15	4.92
0.728-0.748	UB1185	UB-d185-C16-H80-L125	+	UB2060	=	UBS-d185-C16-H80-L125	UB3031	0.630	0.157	0.472	3.15	4.92
0.748-0.768	UB1190	UB-d190-C16-H80-L125	+	UB2060	=	UBS-d190-C16-H80-L125	UB3032	0.630	0.157	0.472	3.15	4.92
0.768-0.787	UB1195	UB-d195-C20-H80-L125	+	UB2060	=	UBS-d195-C20-H80-L125	UB3033	0.787	0.157	0.472	3.15	4.92
0.787-0.807	UB1200	UB-d200-C20-H80-L125	+	UB2060	=	UBS-d200-C20-H80-L125	UB3034	0.787	0.157	0.472	3.15	4.92
0.807-0.827	UB1205	UB-d205-C20-H80-L125	+	UB2060	=	UBS-d205-C20-H80-L125	UB3035	0.787	0.157	0.472	3.15	4.92
0.827-0.846	UB1210	UB-d210-C20-H80-L125	+	UB2060	=	UBS-d210-C20-H80-L125	UB3036	0.787	0.157	0.472	3.15	4.92

UBURR

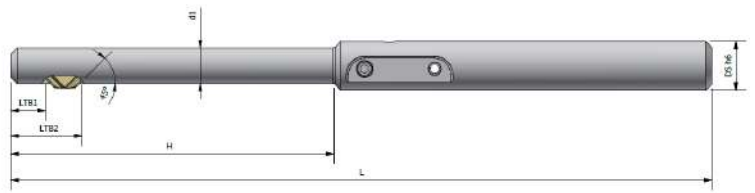
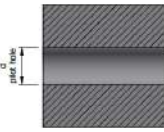



UBURR TOOL-HOLDERS (Inch) cont'd.

Ød min. PILOT HOLE RANGE	SKU TOOL-HOLDER	DESCRIPTION TOOL-HOLDER	+	SKU BLADE	=	DESCRIPTION SET	SKU SET	ØDS h6	LTB1 ⁽²⁾	LTB2 ⁽²⁾	H	L
0.846-0.866	UB1215	UB-d215-C20-H80-L125	+	UB2060	=	UBS-d215-C20-H80-L125	UB3037	0.787	0.157	0.472	3.15	4.92
0.866-0.886	UB1220	UB-d220-C20-H80-L125	+	UB2060	=	UBS-d220-C20-H80-L125	UB3038	0.787	0.157	0.472	3.15	4.92
0.886-0.906	UB1225	UB-d225-C20-H80-L125	+	UB2060	=	UBS-d225-C20-H80-L125	UB3039	0.787	0.157	0.472	3.15	4.92
0.906-0.925	UB1230	UB-d230-C20-H80-L125	+	UB2060	=	UBS-d230-C20-H80-L125	UB3040	0.787	0.157	0.472	3.15	4.92
0.925-0.945	UB1235	UB-d235-C20-H80-L125	+	UB2060	=	UBS-d235-C20-H80-L125	UB3041	0.787	0.157	0.472	3.15	4.92
0.945-0.965	UB1240	UB-d240-C20-H80-L125	+	UB2060	=	UBS-d240-C20-H80-L125	UB3042	0.787	0.157	0.472	3.15	4.92
0.965-0.984	UB1245	UB-d245-C20-H80-L125	+	UB2060	=	UBS-d245-C20-H80-L125	UB3043	0.787	0.157	0.472	3.15	4.92
0.984-1.004	UB1250	UB-d250-C20-H80-L125	+	UB2060	=	UBS-d250-C20-H80-L125	UB3044	0.787	0.157	0.472	3.15	4.92

(1) The **UB2020** blade is designed only for back deburring.

(2) **LTB** (Length to Blade)

UX Tool-holder Spare Parts:

-  Hex L-Key - SP0105 0.050" 1 + 1/16 /1 + 9/16
-  Blade Clamping Screw - UB0021 M2.5 X 0.35



For additional details about our UBURR line, including the complete product range and technical guidelines, please visit our website at: <https://nogamt.com/products/uburr-2/>

CUTTING RECOMMENDATIONS

The table shown on page 54-55 presents cutting recommendations, outlining initial feed rates and cutting speed for materials group based on ISO 513 and VDI 3323 standards.





(1) To ensure optimal performance and tool-life under varying conditions:

- For moderate tool-holder or workpiece stability, consider reducing feed rates by up to 10%.
- For poor tool-holder or workpiece stability, it's advisable to decrease feed rates by up to 30%.

Additionally, the operator must ensure the utilization of appropriate coolant media directed to the cutting tip of the blade and right-hand machining (clockwise).

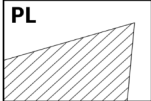
CUTTING RECOMMENDATIONS

ISO	MATERIAL		CONDITION	As is AISI/SAE/ASTM	DIN W.-Nr.	
P	Non-Alloy Steel and Cast Steel Free Cutting Steel	<0.25%C	Annealed	1020	1.0044	
		≥0.25%C	Annealed	1035	1.0501	
		<0.55%C	Quenched and tempered	1045	1.1201	
		≥0.55%C	Annealed	1055	1.0535	
		≥0.55%C	Quenched and tempered	1060	1.1221	
	Low Alloy and Cast Steel (less than 5% of Alloying Elements)			Annealed	G92600	1.5028
				Quenched and Tempered	4130	1.7218
					4142	1.2332
	High-Alloy Steel, Cast Steel and Tool Steel			Annealed	H13	1.2344
				Quenched and Tempered	M33	1.3249
Stainless Steel, Cast Steel			Ferritic / Martensitic	420	1.4021	
			Martensitic			
M	Stainless Steel, Cast Steel		Austenitic, Duplex	304L	1.4306	
K	Grey Cast Iron (GG)		Ferritic / Pearlitic	Class 25	0.6015	
			Pearlitic / Martensitic	Grade H20	0.36037	
	Nodular Cast Iron (GGG)		Ferritic	60-40-18	0.7043	
			Pearlitic	F33500	0.7050	
	Malleable Cast Iron		Ferritic	A47	0.8135	
		Pearlitic	A220 Class	0.8155		
N	Aluminum - Wrought Alloys		Not Hardenable	5005	3.3315	
			Hardenable	7075	3.4365	
	Aluminum - Cast Alloys	<12%Si	Not Hardenable	518	3.3292	
		>12%Si	Hardenable	515	3.3241	
		>12%Si	High Temperature	390		
	Copper Alloys	≥ 1% Pb	Free Cutting	C36000	2.0375	
			Brass	C22000	2.0230	
			Electrolytic Copper	C63000	2.0966	
	Non Metallic		Duroplastics, Fiber Plastics	Bakelite		
Hard Rubber			Ebonite			
S	High Temperature Alloys	Fe based	Annealed	330	1.4864	
			Hardened	S590	1.4977	
		Ni or Co based	Annealed	Inconoly 825	2.4858	
			Hardened	Inconel 718	2.4668	
	Titanium Alloys		Cast	Nimocast K24	2.4674	
			Pure	Titanium G.1	3.7024	
			Alpha+Beta Alloys, Hardened	Titanium G.5	3.7165	
H	Hardened steel		Hardened	HARDOX 500		
			Hardened	HARDOX EXTREME		
	Chilled Cast Iron		Cast	A532 IIIA 25% Cr	0.9650	
	Cast Iron		Hardened	A532 IIID 20% CrMo	0.9645	
C	Carbon Fiber Re-inforced Plastics (CFRP)		Cured	-		
	Glass Fiber Re-inforced Plastics (GFRP)					

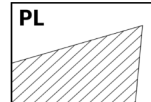
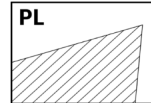
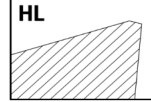
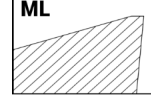
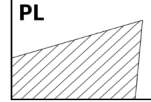
	HSS BLADE	CARBIDE BLADE	HSS or CARBIDE	HSS or CARBIDE		
	Vc cutting speed ⁽¹⁾	Vc cutting speed ⁽¹⁾	Vc cutting speed ⁽¹⁾	fr cutting speed ⁽¹⁾		
ISO	UNCOATED m/min. sfm	COATED m/min. sfm	COATED m/min. sfm	COATED/ UNCOATED m/min. ipr	RECOMMENDED CHIP-FORMER	COOLANT
P	25-45 80-150	45-65 100-165	60-120 200-390	0.08 - 0.20/ 0.003 - 0.008		AIR / WET
	20-45 80-150	35-65 115-165	50-120 165-395	0.08 - 0.20/ 0.003 - 0.008		
	20-40 65-130	35-55 115-180	50-100 165-330			
	15-35 50-115	30-50 100-165	45-90 150-295	0.08 - 0.15/ 0.003 - 0.006		
M	15-30 50-100	30-55 100-180	50-100 165-330	0.08 - 0.15/ 0.003 - 0.006		WET
K	20-35 65-115	35-55 115-180	60-120 200-395	0.08 - 0.25/ 0.003 - 0.012		AIR / WET
	30-70 100-230	40-90 130-295	50-100 165-330	0.08 - 0.20/ 0.005 - 0.008		
N	50-70 165-230	75-120 245-395	100-160 330-525	0.10 - 0.30/ 0.004 - 0.012		WET
	30-60 100-200	45-100 150-330	90-130 295-425			
	60-100 195-330	90-150 295-490	180-305 600-1000			
S	10-15 33-50	15-35 50-115	40-80 130-260	0.10 - 0.20/ 0.005 - 0.008		WET
	NOT RECOMMENDED	10-15 33-50	25-40 80-130			
	10-15 33-50	15-20 50-65	30-60 100-165			
H	NOT RECOMMENDED	10-20 10-20 30-65	30-50 100-165	0.04 - 0.06/ 0.0015 - 0.0024		AIR
		10-15 30-50	30-40 100-130			
		15-20 50-65	45-50 145-165			
		10-20 30-65	30-50 100-165			
C	NOT RECOMMENDED		90-140 295 - 460	0.05 - 0.25 / 0.002 - 0.010		AIR/ WET
			90-350 295 - 1150			

this
is **U**
ThINking!
INSIDE!

ULTIMATE SERIES

**UNCOMPROMISING QUALITY
IN EVERY TOOL**

**All NOGA products meet the strict
requirements of ISO 9001 and ISO 14001.**

NOGA reserves the right to make changes in any of its products without prior notice. © Copyright NOGA Engineering & Technology (2008) Ltd. All rights reserved. No part of this publication may be reproduced, transcribed, stored in an electronic retrieval system, translated into any language or computer language, or be transmitted in any form whatsoever without the prior written consent of the publisher.

To learn more about
NOGA MT and explore
our full product range,
visit our website at:
www.nogamt.com



N | **NOGA MT**
MACHINE TOOLS
Always evolving