



**NOGA MT**  
MACHINE TOOLS



# **UFIBER**

**ADVANCED CERAMIC BRUSHES FOR PRECISION  
AND DURABILITY IN SURFACE TREATMENT**

# UFIBER

## THE NEW NOGA MT LINE OF CERAMIC BRUSHES FOR SURFACE TREATMENT

In today's fast-paced manufacturing environment, achieving superior surface finishes while maximizing efficiency is more critical than ever. NOGA MT is excited to introduce the new **UFIBER** Brush, a line of advanced ceramic fiber brushes designed to meet the highest standards of precision and durability in surface treatment applications.

### UFIBER BRUSH HIGHLIGHTS

#### NANO-TECHNOLOGY PRECISION

**UFIBER** brushes utilize cutting-edge nano-technology to provide superior surface roughness control, exceptional wear resistance, and extended tool life. This innovation leads to fewer tool changes, longer operation times and lower production costs.

#### 3-IN-1 FUNCTIONALITY

Combining deburring, polishing, and finishing in a single tool, **UFIBER** brushes streamline the manufacturing process, reducing the need for multiple tools and operations.

#### VERSATILE APPLICATIONS

Suitable for a wide range of tasks, including surface polishing, inner diameter polishing and small point polishing. **UFIBER** brushes perform consistently even on complex geometries and hard-to-reach areas.

#### AUTOMATION READY

**UFIBER** brushes are compatible with CNC machines and robot arms, making them ideal for integration into automated manufacturing processes.



# UFIBER FEATURES

## NANO TECHNOLOGY FOR PRECISION POLISHING

**UFIBER** filament’s structure leverages nano-technology to refine the grain structure of each ceramic fiber, transitioning from traditional micron-sized grains to state-of-the-art nano-sized grains. This innovation allows each fiber to maintain its edge throughout the polishing process, ensuring a consistently smooth and precise finish while offering superior wear resistance and durability.

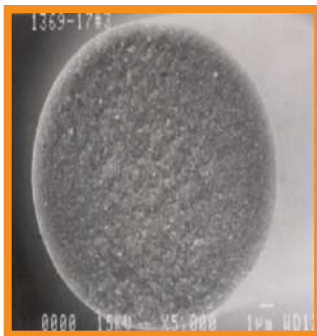

**NOGA NANO TECHNOLOGY**

**UNMATCHED  
PRECISION**

**CUTTING-EDGE  
TECHNOLOGY**

**SUPERIOR  
PERFORMANCE**

versus



**COMPETITORS**

**LIMITED  
PRECISION**

**OUTDATED  
TECHNOLOGY**

**LOWER  
DURABILITY**

## UNMATCHED SURFACE QUALITY

**UFIBER** bristles move beyond conventional grain structures, reducing them to nano size. This transformation results in significantly finer and more uniform surface finishes, even on the most demanding tasks. The bristle’s ability to produce the finest polishing surfaces with exceptional efficiency makes them ideal for applications where surface quality is critical.

The graph illustrates the relationship between surface roughness (Ra) and processing time using different grit sizes of a **UFIBER** end brush.

As demonstrated in the graph, **UFIBER** brushes consistently reduce surface roughness with extended processing times, even on tough materials like S50C. Whether you’re working with coarse or fine grit sizes, **UFIBER** brushes deliver smoother finishes faster, making them the perfect choice for industries where surface quality is paramount.

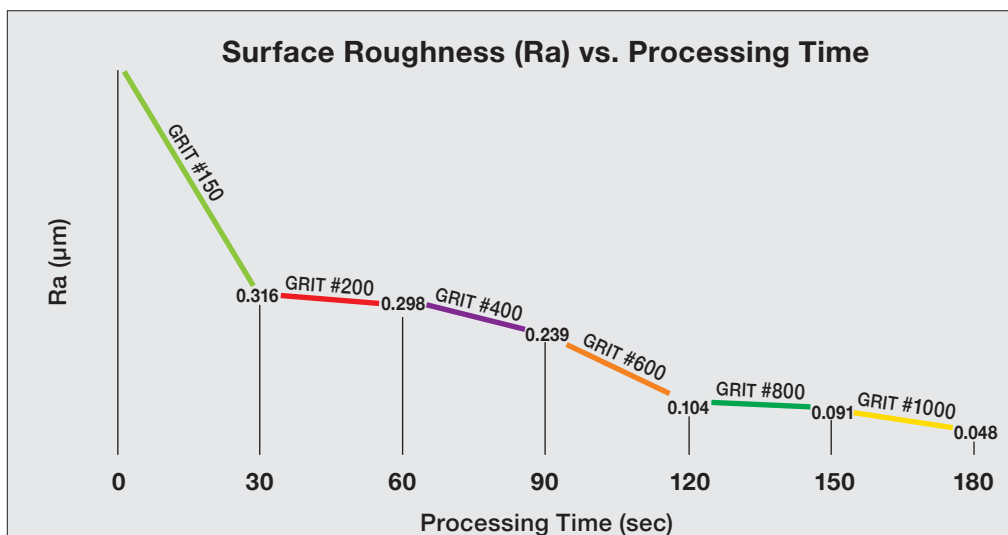

- Material: SAE 1050 / S50C / Wr. 1.1206
- Rotational speed: 3200 rpm

# UFIBER FEATURES

## WIDE GRIT RANGE

Wide Grit Range **UFIBER** bristles are available in grits ranging from #150 to #6000, providing flexibility to handle various work materials and burr conditions.



◀ **HARD**

**SOFT** ▶

## EFFICIENT AUTOMATION

Efficient Automation with the right selection of brush type and grit, **UFIBER** brushes facilitate the automation of deburring, removal of toolmarks and the polishing processes with the same machine code or robotic arms, making them an excellent choice for advanced manufacturing environments.

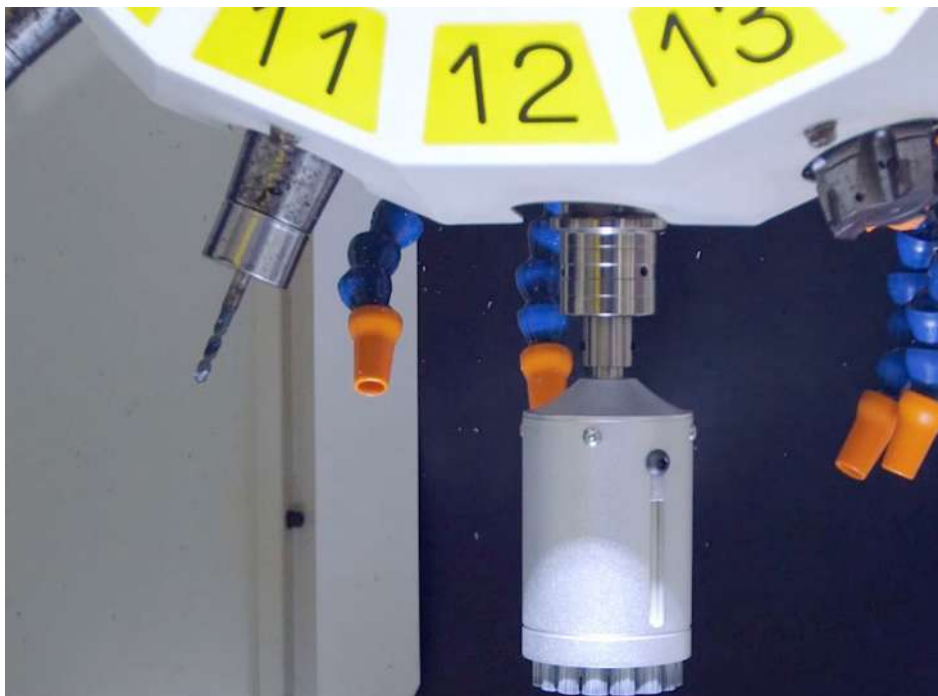

# UFIBER PRODUCT RANGE

THE NEW NOGA MT **UFIBER** BRUSH APPLICATIONS

---

## SURFACE BRUSH



## CROSS-HOLE BRUSH

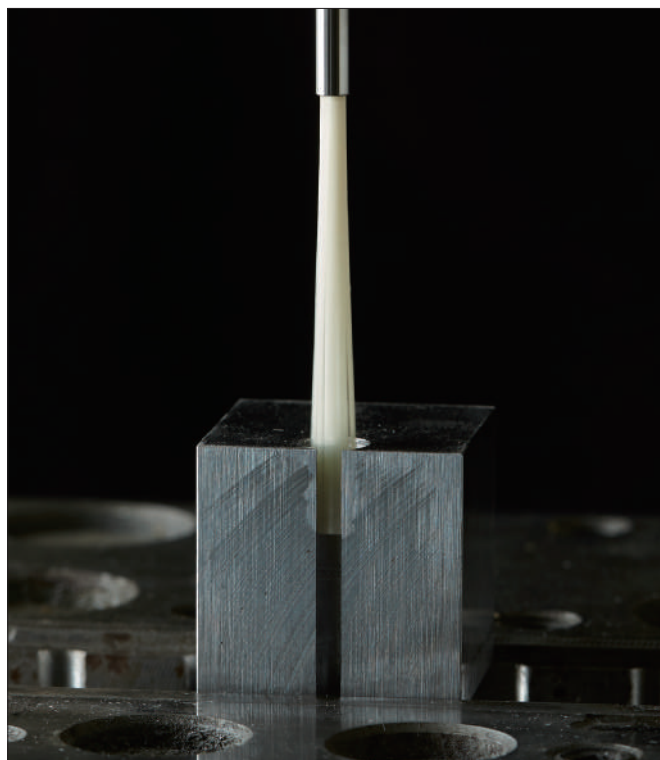

## POINT BRUSH



## END BRUSH



# UFIBER

## SURFACE TYPE BRUSHES

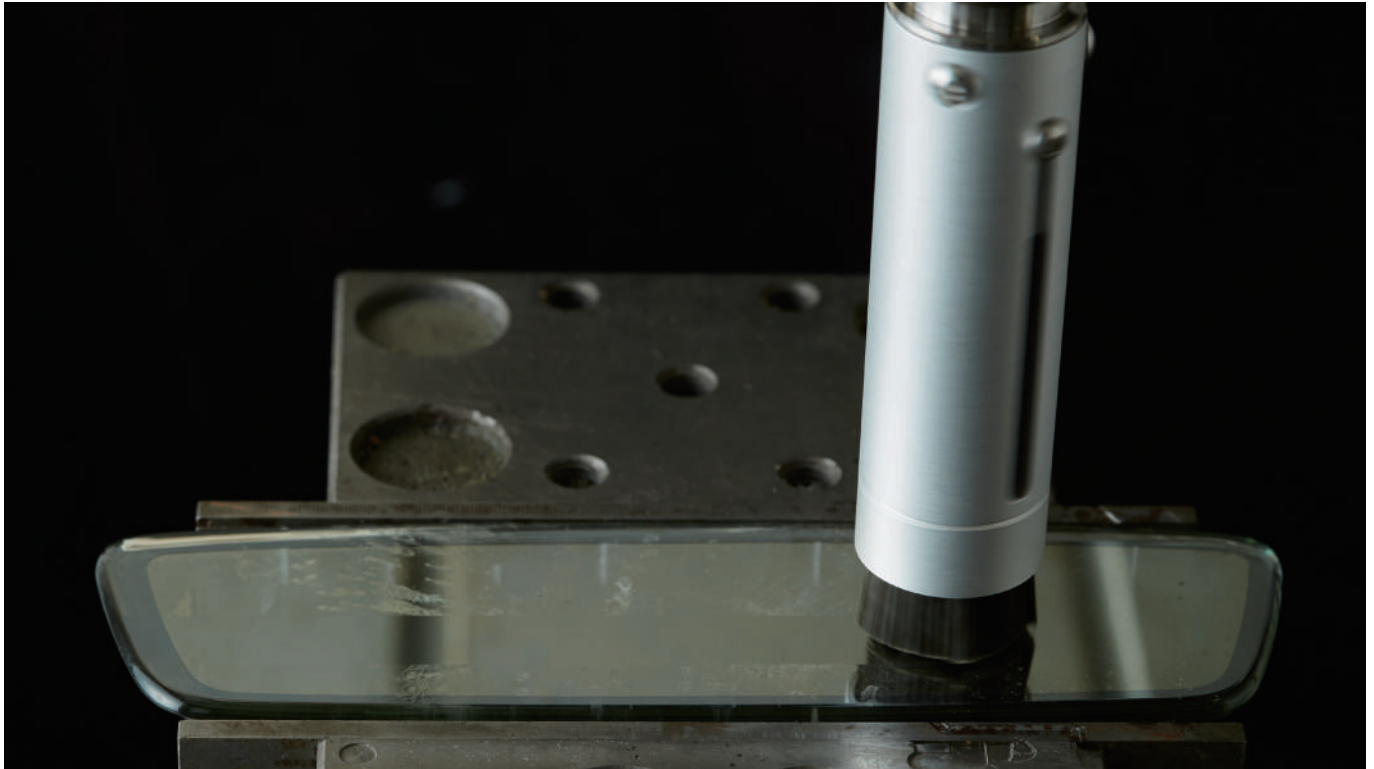

Designed for surface polishing and deburring, ideal for achieving uniform finishes on flat surfaces. Tip-cutting brushes are designed to fit into a sleeve with the tool shank, making them ideal for automated deburring in CNC machines, robots, and other equipment.

- Available Range: **6, 15, 25, 40, 60, 100 mm / 0.236, 0.590, 0.984, 1.575, 2.362, 3.937"**



**BEFORE**



**AFTER**



Ra= 0.707µm

Ra= 0.086µm

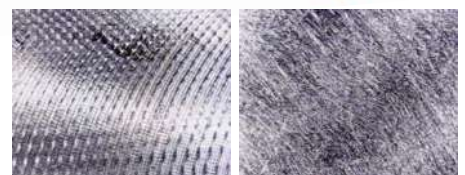

Ra= 1.408µm

Ra= 0.302µm

- **Material:** Inconel 625.
- **Surface Brush:** UF1325 / UF-FB-W-D025-L75  
Ø25 Grit#400 (Violet)

- **Material:** S25S (similar to SAE 1025).
- **Surface Brush:** UF1125 / UF-FB-G-D025-L75  
Ø25 Grit#150 (Green)

# UFIBER

## SURFACE TYPE BRUSHES



The surface brush can also function as a cross-hole brush, leveraging centrifugal force during rotation to expand and efficiently remove fine burrs from the inner surfaces of cylinders.

To use this feature, simply remove the sleeve and attach the appropriate shank as specified by the ØDS parameter in the product specifications. The image below illustrates how the #1200 and #1000 Ø25 surface brushes expand at 5000 RPM. The #1200 brush is more flexible compared to the #1000 brush, allowing for greater expansion.

It is recommended to start with the #1200 brush. If burrs remain, switching to the #1000 brush is advisable.

Please note that the #1200 brush is more susceptible to breakage than other grits. To prevent damage, always insert the brush into the hole before starting rotation and stop the rotation before removing it from the hole.



UF1625 / UF-FB-W-D025-L75 at 5000 rpm      UF1725 / UF-FB-R-D025-L75 at 5000 rpm

# UFIBER

## CROSS-HOLE TYPE BRUSHES



Designed for inner diameter polishing and cross-hole burr removal. The brush expands due to centrifugal forces, allowing it to conform precisely to the pilot hole diameter, making it versatile for various applications.

- Available Range: **Ø1.5, 3.0, 5.0, 7.0 mm / 0.059, 0.118, 0.197, 0.276"**
- Expansion Range: **Ø20 - 3.5mm / 0.787 - 0.138"**

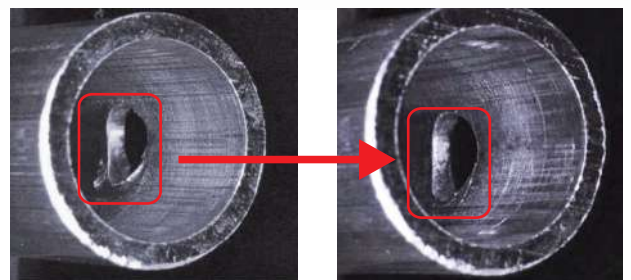
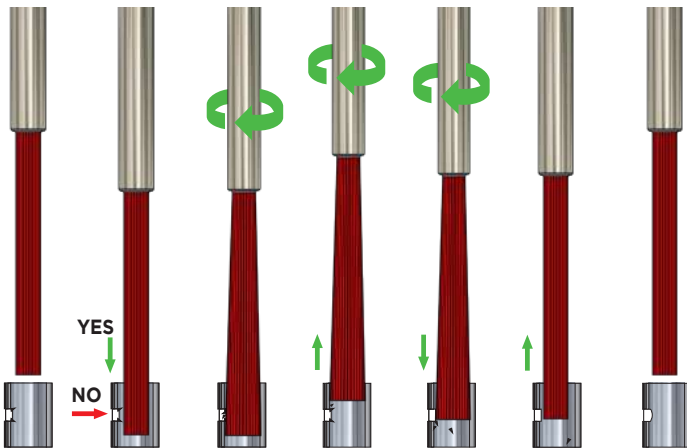

**BEFORE**

**AFTER**



Scan the QR code or click-on the link for our Youtube application demo

<https://tinyurl.com/z6af72rv>



# UFIBER

## POINT TYPE BRUSHES



Suitable for precision work in small or complex areas, ideal for removing cutter marks, polishing, and finishing parts with small or narrow features. Suitable for use in CNC machines, robots, or hand-held rotary tools.

- Available with: **Ø1.0, 1.5, 2.0, 2.5, 3.0 mm / 0.039, 0.059, 0.079, 0.098, 0.118"**



# UFIBER

## END TYPE BRUSHES



Designed for use with hand-held rotary tools and CNC machines, making it ideal for precise finishing tasks, especially in tight or recessed areas where traditional brushes may fall short. This brush features high bending strength and can operate at max. 12000 RPM without the risk of filament breakage.

- Available with: **Ø 5mm / 0.197" - flat surface or 90° angled tip**

\* The brush tip can be angled using a diamond disk on a lathe or spindle.

\*\* Not recommended with pneumatic powered tools.

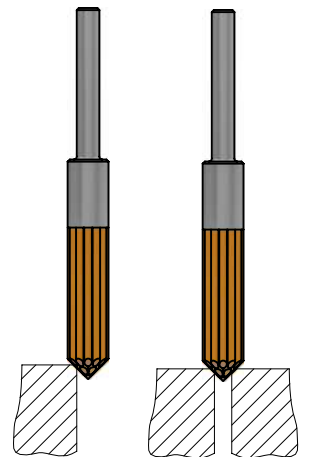

- **Flat Design:** Designed for uniform deburring and finishing of flat surfaces and large areas.
- **Wide Contact Area:** The flat edge ensures consistent and even surface treatment.
- **Versatile Usage:** Suitable for smoothing outer edges, planar surfaces, and broader geometries.

- **Angled Design:** Allows for easy access to confined spaces and hard-to-reach areas.
- **Enhanced Control:** The pointed edge provides better control for selective deburring tasks.
- **Versatility:** Suitable for deburring geometries with complex shapes and sharp angles

# UFIBER

## BENEFITS OF NOGA MT UFIBER BRUSHES

- **3-in-1 Functionality:** **UFIBER** brushes combine deburring, polishing and finishing in a single tool. This multifunctional capability reduces the need for multiple tools and operations, streamlining the manufacturing process and saving time and costs.
- **Superior Surface Finish:** The nano-bonded **UFIBER** bristles reduce polishing scratches, achieving a finer surface finish compared to conventional nylon brushes or ceramic bristles that use micro-bond technology.

Conventional brushes

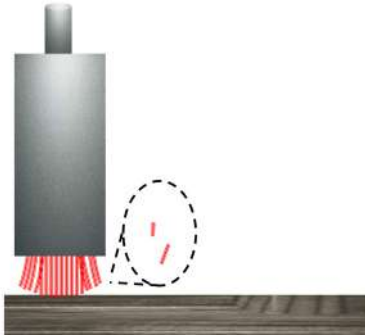

- **Extended Tool Life:** **UFIBER** ceramic fiber bristles offer better control over spreading compared to conventional brushes, while maintaining strong polishing power even at high speeds. This leads to a longer lifespan for the brushes, reducing the need for frequent replacements.
- **Stable Grinding Power:** **UFIBER** brushes provide consistent grinding power, supporting the automation of deburring and tool mark removal without the need to frequently change the brush shape.

UFIBER



- **Time Efficiency:** **UFIBER** brushes have 60 times more grinding power, reducing the process time by 20% compared to abrasive nylon brushes. This efficiency translates into faster production cycles and lower overall costs.
- **Automation Ready:** **UFIBER** ceramic brushes, specifically designed for seamless integration with automated systems such as machine tools and robotic arms, improve production processes by **up to 20 times faster**.
- **Versatility:** **UFIBER** brushes excel in a wide range of applications and materials, with 10 different bristle grits available, making them suitable for diverse industries and tasks.
- **High Bending Strength:** The brushes retain their shape and performance even under high RPM conditions, ensuring reliable operation and consistent results.

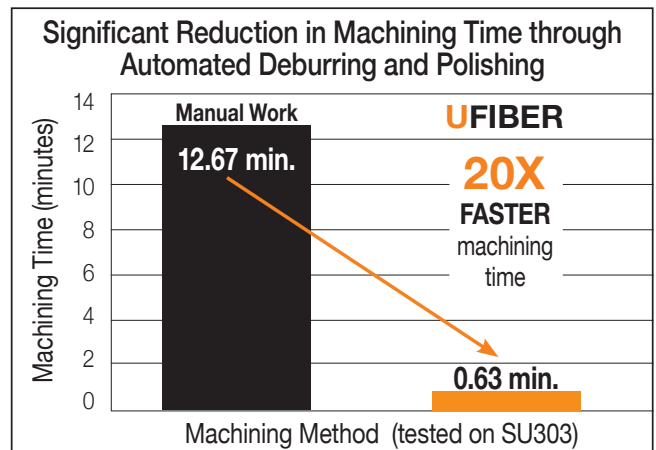

### Bending strength

**130%**  
Save Costs

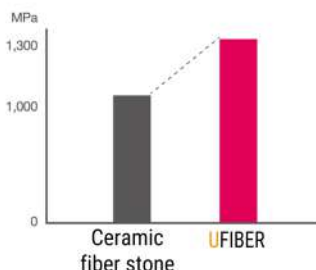

### Grinding performance

**200%**  
Save time

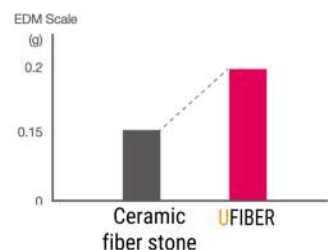

# **UFIBER** APPLICATIONS

The **UFIBER** brushes are suitable for any type of material in the market, including composite materials (FRP), copper, aluminium, SUS, carbon steels, stainless steel, and hardened materials. This versatility makes **UFIBER** brushes ideal for a wide range of industrial applications, ensuring high performance across various materials.

## **AUTOMOTIVE INDUSTRY**

Ideal for deburring and finishing engine components, transmission parts, and other metal surfaces, **UFIBER** brushes ensure smooth finishes and high precision, critical in automotive manufacturing.

## **AEROSPACE**

**UFIBER** brushes are suitable for precision surface treatment of aircraft components, ensuring compliance with stringent industry standards for safety and performance.

## **MEDICAL DEVICES**

**UFIBER** brushes ensure smooth, polished finishes on surgical instruments and implants, which are critical for both functionality and safety in medical applications.

## **GENERAL MANUFACTURING**

**UFIBER** brushes are versatile enough to be used in various manufacturing processes, including metalworking, plastics, and composites. They can handle different materials and are adaptable to a wide range of surface treatment needs.



# UFIBER BRUSH CODING SYSTEM:

## SPECIFICATIONS AND IDENTIFICATION

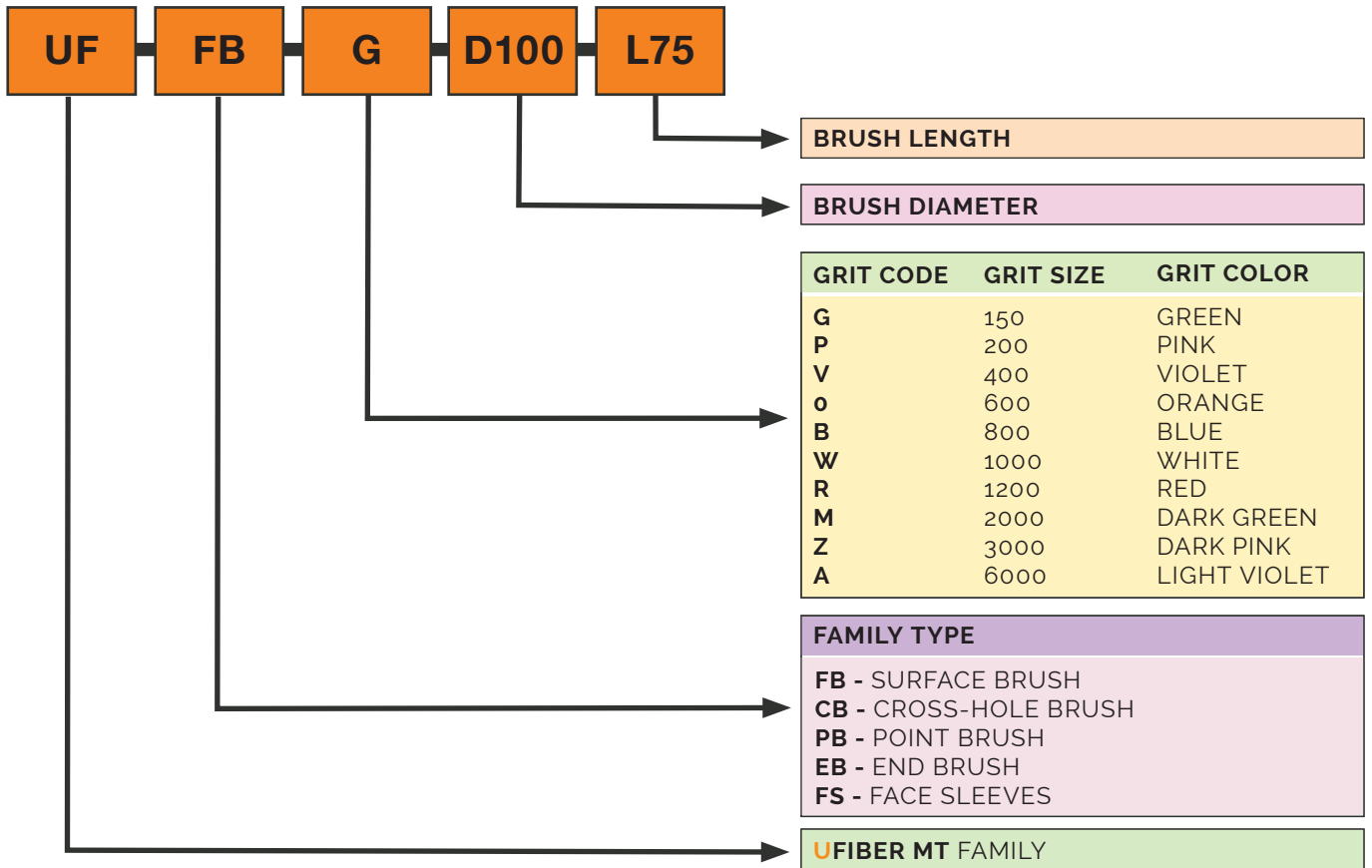

## GRIT OPTIONS FOR MACHINING REQUIREMENTS

Selecting the right brush grit by machined materials or burr conditions:



# UFIBER

## SURFACE BRUSH ITEM LIST

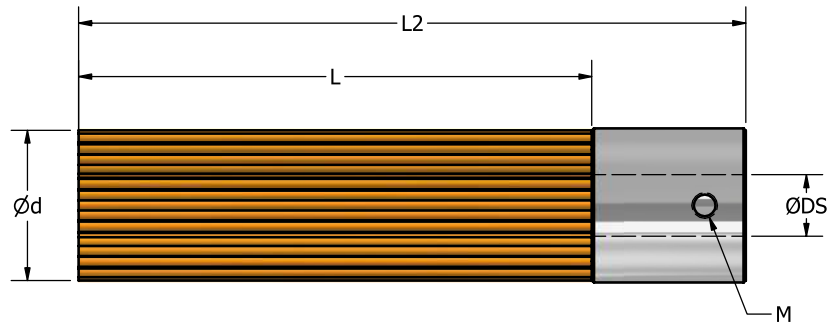

SKU	DESCRIPTION	GRIT SIZE	$\varnothing d$	$\varnothing DS$	L	L2	Spare Parts (for M) LN Key with Screw	Weight gram	Depth Of Cut (DOC)			Rec. R.P.M.	Feed mm/min Inch/min	Brush Projection mm/ Inch												
			mm / Inch	mm / Inch	mm / Inch	mm / Inch			Polishing mm / Inch	Deburring mm / Inch	Max. mm / Inch															
UF1106	UF-FB-G-D006-L30	150																								
UF1206	UF-FB-P-D006-L30	200																								
UF1306	UF-FB-V-D006-L30	400																								
UF1406	UF-FB-O-D006-L30	600																								
UF1506	UF-FB-B-D006-L30	800	$\varnothing 6 /$ 0.236	N/A	30 / 1.181	42.5 / 1.673	N/A	3	0.2 / 0.008	0.5 / 0.02	1.2 / 0.05	9000- 12000	2000 / 79	10 / 0.394												
UF1606	UF-FB-W-D006-L30	1000																								
UF1706	UF-FB-R-D006-L30	1200																								
UF1806	UF-FB-M-D006-L30	2000																								
UF1906	UF-FB-Z-D006-L30	3000																								
UF1006	UF-FB-A-D006-L30	6000																								
UF1115	UF-FB-G-D015-L50	150																								
UF1215	UF-FB-P-D015-L50	200																								
UF1315	UF-FB-V-D015-L50	400																								
UF1415	UF-FB-O-D015-L50	600																								
UF1515	UF-FB-B-D015-L50	800	$\varnothing 15 /$ 0.590	$\varnothing 6 /$ 0.236	50 / 1.969	65 / 2.560	UF0019/ M3 x 0.5 x 4mm DH0005/ LN Key 1.5mm	7	0.2 / 0.008	0.5 / 0.02	1.2 / 0.05	5700- 7200	2000 / 79	10 / 0.394												
UF1615	UF-FB-W-D015-L50	1000																								
UF1715	UF-FB-R-D015-L50	1200																								
UF1815	UF-FB-M-D015-L50	2000																								
UF1915	UF-FB-Z-D015-L50	3000																								
UF1015	UF-FB-A-D015-L50	6000																								
UF1125	UF-FB-G-D025-L75	150																								
UF1225	UF-FB-P-D025-L75	200																								
UF1325	UF-FB-V-D025-L75	400																								
UF1425	UF-FB-O-D025-L75	600																								
UF1525	UF-FB-B-D025-L75	800	$\varnothing 25 /$ 0.984	$\varnothing 9 /$ 0.354	75 / 2.952	100/ 3.937	UF0018/ M4 x 0.7 x 8mm UF0020/ LN Key 2mm	21	0.2 / 0.008	0.5 / 0.02	1.2 / 0.05	5000- 6000	2000 / 79	10 / 0.394												
UF1625	UF-FB-W-D025-L75	1000																								
UF1725	UF-FB-R-D025-L75	1200																								
UF1825	UF-FB-M-D025-L75	2000																								
UF1925	UF-FB-Z-D025-L75	3000																								
UF1025	UF-FB-A-D025-L75	6000																								
UF1140	UF-FB-G-D040-L75	150																								
UF1240	UF-FB-P-D040-L75	200																								
UF1340	UF-FB-V-D040-L75	400																								
UF1440	UF-FB-O-D040-L75	600																								
UF1540	UF-FB-B-D040-L75	800	$\varnothing 40 /$ 1.575	$\varnothing 12 /$ 0.472	75 / 2.952	96 / 3.780	UF0017/ M6 x 1 x 16mm DB0007/ LN Key 3mm	26	0.2 / 0.008	0.5 / 0.02	1.2 / 0.05	2700- 3600	2000 / 79	10 / 0.394												
UF1640	UF-FB-W-D040-L75	1000																								
UF1740	UF-FB-R-D040-L75	1200																								
UF1840	UF-FB-M-D040-L75	2000																								
UF1940	UF-FB-Z-D040-L75	3000																								
UF1040	UF-FB-A-D040-L75	6000																								

# UFIBER

## SURFACE BRUSH ITEM LIST

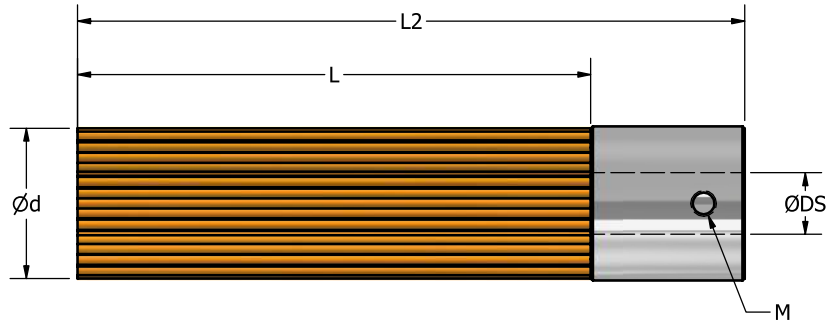

SKU	DESCRIPTION	GRIT SIZE	Ød		L	L2	Spare Parts (for M) LN Key with Screw	Weight gram	Depth Of Cut (DOC)			Rec. R.P.M.	Feed mm/min Inch/min	Brush Projection mm / Inch
			mm / Inch	mm / Inch					Polishing mm / Inch	Deburring mm / Inch	Max. mm / Inch			
UF1160	UF-FB-G-D060-L75	150	Ø60 / 2.362	Ø13/ 0.512	75 / 2.952	90 / 3.780	UF0016/ M6 x 1 x 20mm DB0007/ LN Key 3mm	70	0.2 / 0.008	0.5 / 0.02	1.2 / 0.05	1800- 2400	2000 / 79	10 / 0.394
UF1260	UF-FB-P-D060-L75	200												
UF1360	UF-FB-V-D060-L75	400												
UF1460	UF-FB-O-D060-L75	600												
UF1560	UF-FB-B-D060-L75	800												
UF1660	UF-FB-W-D060-L75	1000												
UF1760	UF-FB-R-D060-L75	1200												
UF1860	UF-FB-M-D060-L75	2000												
UF1960	UF-FB-Z-D060-L75	3000												
UF1060	UF-FB-A-D060-L75	6000												
UF1100	UF-FB-G-D100-L75	150	Ø100 / 3.937	Ø16 / 0.630	50 / 2.952	97 / 3.820	UF0015/ M6 x 1 x 25mm DB0007/ LN Key 3mm	140	0.2 / 0.008	0.5 / 0.02	1.2 / 0.05	1000- 1400	2000 / 79	10 / 0.394
UF1200	UF-FB-P-D100-L75	200												
UF1300	UF-FB-V-D100-L75	400												
UF1400	UF-FB-O-D100-L75	600												
UF1500	UF-FB-B-D100-L75	800												
UF1600	UF-FB-W-D100-L75	1000												
UF1700	UF-FB-R-D100-L75	1200												
UF1800	UF-FB-M-D100-L75	2000												
UF1900	UF-FB-Z-D100-L75	3000												
UF1000	UF-FB-A-D100-L75	6000												

## SURFACE BRUSH SLEEVE ITEM LIST

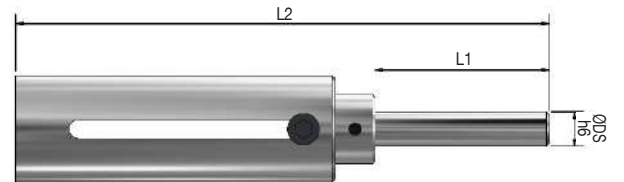

Suitable for	SKU	DESCRIPTION	ØDS		L1	L2	Weight gram	Clamping Screw MxPxLength	SKU	LN Key S (mm)	SKU
			mm / Inch	mm / Inch							
Ø 6mm / 0.236"	UF5506	UF-FS-006-C06-L70	Ø6 / 0.236	30 / 1.181	70 / 2.756	30	M3x0.5x4	UF0010	2.5	UF0021	
Ø 16mm / 0.590"	UF5515	UF-FS-015-C06-L90	Ø6 / 0.236	30 / 1.181	90 / 3.543	40	M3x0.5x6	UF0011	2.5	UF0020	
Ø 25mm / 0.984"	UF5525	UF-FS-025-C10-L140	Ø10 / 0.394	30 / 1.181	140 / 5.512	160	M4x0.7x10	UF0012	3.0	UF0021	
Ø 40mm / 1.575"	UF5540	UF-FS-040-C12-L140	Ø12 / 0.472	30 / 1.181	140 / 5.512	200	M6x1.0x10	UF0013	4.0	UF0022	
Ø 60mm / 2.362"	UF5560	UF-FS-060-C12-L150	Ø12 / 0.472	40 / 1.575	145 / 5.708	320	M6x1.0x10	UF0013	4.0	UF0022	
Ø100mm / 3.937"	UF5500	UF-FS-100-C16-L155	Ø16 / 0.630	40 / 1.575	155 / 6.102	670	M8x1.25x16	UF0014	5.0	UF0023	

# UFIBER

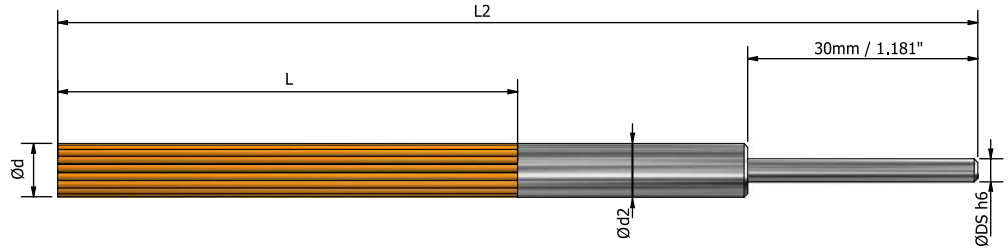

## CROSS-HOLE BRUSH ITEM LIST

SKU	DESCRIPTION	GRIT SIZE	Ød	Ød2	ØDS	L	L2	Weight gram	Max. Spindle Speed Min <sup>-1</sup>	Pilot Hole Dia.	
			mm / Inch	mm / Inch	mm / Inch	mm / Inch	mm / Inch			mm / Inch	GRIT: #150 - #1000 mm / Inch
UF2115	UF-CH-G-D015-L50	150	Ø 1.5 / 0.059	Ø 2.5 / 0.098	Ø 3 / 0.118	50 / 1.97	120 / 4.72	3	20000	3.5 - 5 / 0.138- 0.197	3.5 - 5 / 0.138- 0.197
UF2215	UF-CH-P-D015-L50	200									
UF2315	UF-CH-V-D015-L50	400									
UF2415	UF-CH-O-D015-L50	600									
UF2515	UF-CH-B-D015-L50	800									
UF2615	UF-CH-W-D015-L50	1000									
UF2715	UF-CH-R-D015-L50	1200									
UF2815	UF-CH-M-D015-L50	2000									
UF2915	UF-CH-Z-D015-L50	3000									
UF2015	UF-CH-A-D015-L50	6000									
UF2130	UF-CH-G-D030-L60	150	Ø 3 / 0.118	Ø 4 / 0.159	Ø 3 / 0.118	60 / 2.36	130 / 5.12	6	14000	5 - 7 / 0.197- 0.276	-
UF2230	UF-CH-P-D030-L60	200									
UF2330	UF-CH-V-D030-L60	400									
UF2430	UF-CH-O-D030-L60	600									
UF2530	UF-CH-B-D030-L60	800									
UF2630	UF-CH-W-D030-L60	1000									
UF2730	UF-CH-R-D030-L50	1200				50 / 1.97	120 / 4.72	14000	-	5 - 7 / 0.197- 0.276	
UF2830	UF-CH-M-D030-L50	2000									
UF2930	UF-CH-Z-D030-L50	3000									
UF2030	UF-CH-A-D030-L50	6000									
UF2150	UF-CH-G-D050-L60	150	Ø 5 / 0.197	Ø 6 / 0.236	Ø 6 / 0.236						60 / 2.36
UF2250	UF-CH-P-D050-L60	200									
UF2350	UF-CH-V-D050-L60	400									
UF2450	UF-CH-O-D050-L60	600									
UF2550	UF-CH-B-D050-L60	800									
UF2650	UF-CH-W-D050-L60	1000									
UF2750	UF-CH-R-D050-L50	1200				50 / 1.97	120 / 4.72	14000	-	8 - 10 / 0.315- 0.394	
UF2850	UF-CH-M-D050-L50	2000									
UF2950	UF-CH-Z-D050-L50	3000									
UF2050	UF-CH-A-D050-L50	6000									
UF2170	UF-CH-G-D070-L60	150	Ø 7 / 0.276	Ø 8 / 0.315	Ø 6 / 0.236						60 / 2.36
UF2270	UF-CH-P-D070-L60	200									
UF2370	UF-CH-V-D070-L60	400									
UF2470	UF-CH-O-D070-L60	600									
UF2570	UF-CH-B-D070-L60	800									
UF2670	UF-CH-W-D070-L60	1000									
UF2770	UF-CH-R-D070-L50	1200				50 / 1.97	120 / 4.72	14000	-	10 - 20 / 0.394- 0.787	
UF2870	UF-CH-M-D070-L50	2000									
UF2970	UF-CH-Z-D070-L50	3000									
UF2070	UF-CH-A-D070-L50	6000									



# UFIBER END BRUSH ITEM LIST

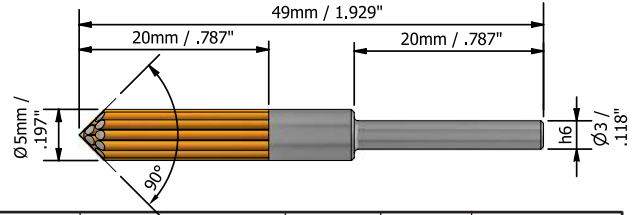
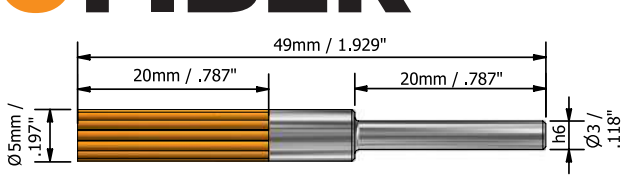

SKU	DESCRIPTION	GRIT SIZE	Weight gram	Max. Spindle Speed Min <sup>-1</sup>
UF4150	UF-EB-G-D5-L20	150	3	12000
UF4250	UF-EB-P-D5-L20	200		
UF4350	UF-EB-V-D5-L20	400		
UF4450	UF-EB-O-D5-L20	600		
UF4550	UF-EB-B-D5-L20	800		
UF4650	UF-EB-W-D5-L20	1000		
UF4750	UF-EB-R-D5-L20	1200		
UF4850	UF-EB-M-D5-L20	2000		
UF4950	UF-EB-Z-D5-L20	3000		
UF4050	UF-EB-A-D5-L20	6000		

SKU	DESCRIPTION	GRIT SIZE	Weight gram	Max. Spindle Speed Min <sup>-1</sup>
UF6150	UF-EB45-G-D5-L20	150	3	12000
UF6250	UF-EB45-P-D5-L20	200		
UF6350	UF-EB45-V-D5-L20	400		
UF6450	UF-EB45-O-D5-L20	600		
UF6550	UF-EB45-B-D5-L20	800		
UF6650	UF-EB45-W-D5-L20	1000		
UF6750	UF-EB45-R-D5-L20	1200		
UF6850	UF-EB45-M-D5-L20	2000		
UF6950	UF-EB45-Z-D5-L20	3000		
UF6050	UF-EB45-A-D5-L20	6000		

## POINT BRUSH ITEM LIST

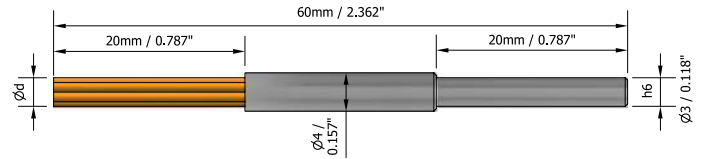
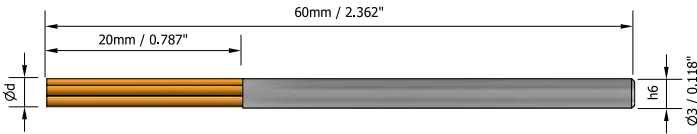

SKU	DESCRIPTION	GRIT SIZE	Ød	Weight gram	Max. Spindle Speed Min <sup>-1</sup>
			mm / Inch		
UF3110	UF-PB-G-D1-L20	150	Ø 1 / 0.039	2	12000
UF3210	UF-PB-P-D1-L20	200			
UF3310	UF-PB-V-D1-L20	400			
UF3410	UF-PB-O-D1-L20	600			
UF3510	UF-PB-B-D1-L20	800			
UF3610	UF-PB-W-D1-L20	1000			
UF3710	UF-PB-R-D1-L20	1200			
UF3810	UF-PB-M-D1-L20	2000			
UF3910	UF-PB-Z-D1-L20	3000			
UF3010	UF-PB-A-D1-L20	6000			
UF3115	UF-PB-G-D1.5-L20	150	Ø 1.5 / 0.059	2	12000
UF3215	UF-PB-P-D1.5-L20	200			
UF3315	UF-PB-V-D1.5-L20	400			
UF3415	UF-PB-O-D1.5-L20	600			
UF3515	UF-PB-B-D1.5-L20	800			
UF3615	UF-PB-W-D1.5-L20	1000			
UF3715	UF-PB-R-D1.5-L20	1200			
UF3815	UF-PB-M-D1.5-L20	2000			
UF3915	UF-PB-Z-D1.5-L20	3000			
UF3015	UF-PB-A-D1.5-L20	6000			
UF3120	UF-PB-G-D2-L20	150	Ø 2 / 0.079	2	12000
UF3220	UF-PB-P-D2-L20	200			
UF3320	UF-PB-V-D2-L20	400			
UF3420	UF-PB-O-D2-L20	600			
UF3520	UF-PB-B-D2-L20	800			
UF3620	UF-PB-W-D2-L20	1000			
UF3720	UF-PB-R-D2-L20	1200			
UF3820	UF-PB-M-D2-L20	2000			
UF3920	UF-PB-Z-D2-L20	3000			
UF3020	UF-PB-A-D2-L20	6000			

SKU	DESCRIPTION	GRIT SIZE	Ød	Weight gram	Max. Spindle Speed Min <sup>-1</sup>
			mm / Inch		
UF3125	UF-PB-G-D2.5-L20	150	Ø 2.5 / 0.098	3	12000
UF3225	UF-PB-P-D2.5-L20	200			
UF3325	UF-PB-V-D2.5-L20	400			
UF3425	UF-PB-O-D2.5-L20	600			
UF3525	UF-PB-B-D2.5-L20	800			
UF3625	UF-PB-W-D2.5-L20	1000			
UF3725	UF-PB-R-D2.5-L20	1200			
UF3825	UF-PB-M-D2.5-L20	2000			
UF3925	UF-PB-Z-D2.5-L20	3000			
UF3025	UF-PB-A-D2.5-L20	6000			
UF3130	UF-PB-G-D3-L20	150	Ø 3 / 0.118	3	12000
UF3230	UF-PB-P-D3-L20	200			
UF3330	UF-PB-V-D3-L20	400			
UF3430	UF-PB-O-D3-L20	600			
UF3530	UF-PB-B-D3-L20	800			
UF3630	UF-PB-W-D3-L20	1000			
UF3730	UF-PB-R-D3-L20	1200			
UF3830	UF-PB-M-D3-L20	2000			
UF3930	UF-PB-Z-D3-L20	3000			
UF3030	UF-PB-A-D3-L20	6000			

# UFIBER

## CASE STUDIES - DEBURRING

### BURR REMOVAL IN AUTOMOTIVE PARTS WITH SURFACE BRUSH



- **Material:** ADC12 (A383.0) Aluminum - Silicon Alloys.
- **Cutting Parameters:** S = 6000RPM, F = 1000mm/min. (34.9inch/min.), DOC = 0.5 mm (0.0196").
- **Surface Brush:** UF1625 / UF-FB-W-D025-L75  
Ø25 Grit#1000 (White)

### BURR REMOVAL IN AEROSPACE PARTS WITH SURFACE BRUSH

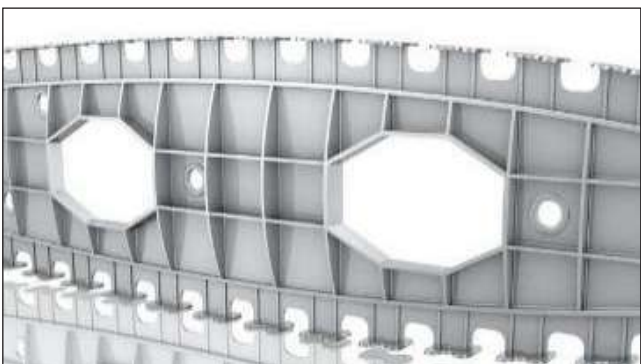

- **Material:** 7075 Aluminum Alloy.
- **Cutting Parameters:** S = 6000RPM, F = 1000mm/min. (34.9inch/min.), DOC = 0.5 mm (0.0196").
- **Surface Brush:** UF1625 / UF-FB-W-D025-L75  
Ø25 Grit#1000 (White)

### BURR REMOVAL IN PIPES WITH CROSS-HOLE BRUSH

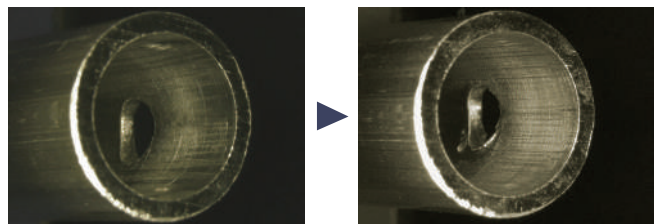

- **Material:** Aluminum.
- **Cutting Parameters:** S = 11000RPM, F = 1100mm/min. (44.3inch/min.).
- **Cross-Hole Brush:** UF2650 / UF-CH-W-D050-L60  
Ø5 Grit#1000 (White)

# UFIBER

## CASE STUDIES - TOOL MARK REMOVAL

### CUTTER MARK REMOVAL WITH SURFACE BRUSH

- **Material:** A7075 Aluminum Alloys.
- **Cutting Parameters:**  
S = 6000RPM, F = 2000mm/min. (79inch/min.),  
DOC = 0.5 mm (0.0196").
- **Surface Brush:** UF1625 / UF-FB-W-D025-L75  
Ø25 Grit#1000 (White)

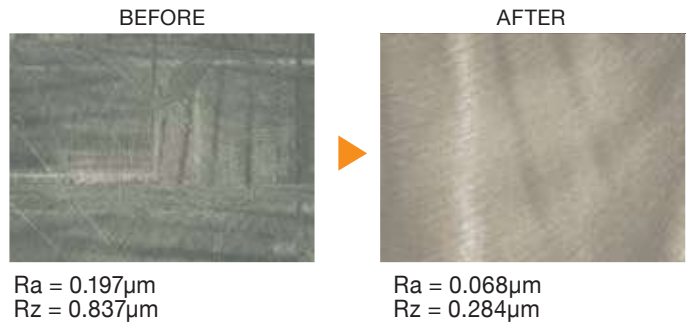

- **Material:** Inconel 625.
- **Cutting Parameters:**  
S = 6000RPM, F = 800mm/min. (32inch/min.),  
DOC = 0.5 mm (0.0196").
- **Surface Brush:** UF1325 / UF-FB-V-D025-L75  
Ø25 Grit#400 (Violet)

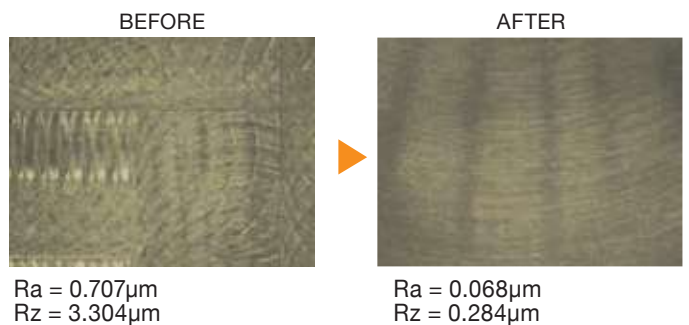

- **Material:** SCM440 / AISI Steel Alloy.
- **Cutting Parameters:**  
S = 6000RPM, F = 1000mm/min. (39.5inch/min.),  
DOC = 0.5 mm (0.0196").
- **Surface Brush:** UF1325 / UF-FB-W-D025-L75  
Ø25 Grit#400 (Violet)

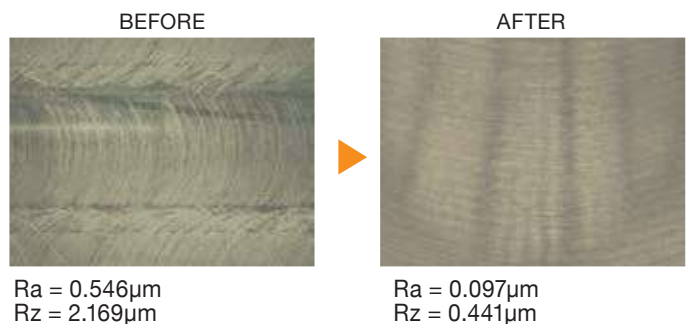

- **Material:** Titanium Ti-6Al-4V.
- **Cutting Parameters:**  
S = 6000RPM, F = 1000mm/min. (39.5inch/min.),  
DOC = 0.5 mm (0.0196").
- **Surface Brush:** UF1325 / UF-FB-W-D025-L75  
Ø25 Grit#400 (Violet)

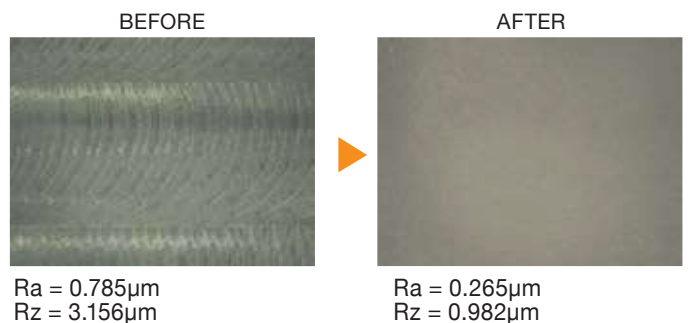

# UFIBER

PIONEERING A NEW ERA IN SURFACE FINISHING



Scan the QR code or click-on the link for our Youtube channel  
<https://tinyurl.com/4fvhmpw>



Scan the QR code or click-on the link for our Youtube channel  
<https://tinyurl.com/4nrmsyyh>

---

**All NOGA products meet the strict requirements of ISO 9001 and ISO 14001.**

NOGA reserves the right to make changes in any of its products without prior notice. © Copyright NOGA Engineering & Technology (2008) Ltd. All rights reserved. No part of this publication may be reproduced, transcribed, stored in an electronic retrieval system, translated into any language or computer language, or be transmitted in any form whatsoever without the prior written consent of the publisher.



For further information we invite you to visit our website: [www.nogamt.com](http://www.nogamt.com)

Scan the QR code or click-on the website link



**NOGA ENGINEERING & TECHNOLOGY (2008) LTD**

P.O.B 55 Dora Industrial Park, Shlomi 2283200, Israel

Tel: 972-4-9808080 | Fax: 972-4-9808638 | E-mail: [noga@noga.com](mailto:noga@noga.com)